

**N-Channel Enhancement-Mode MOSFET**

$V_{DS}$  30V  $R_{DS(ON)}$  13mΩ  $I_D$  50A

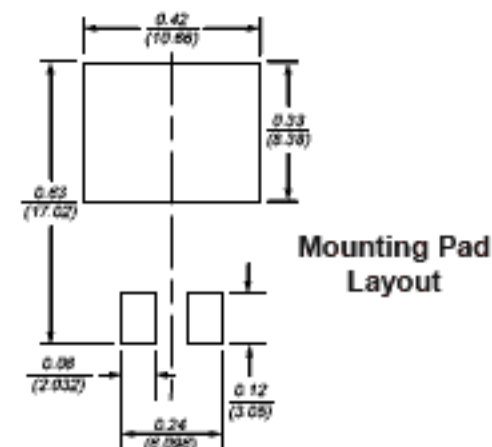

**TO-263AB**

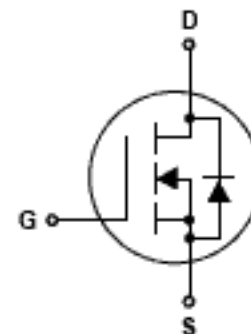
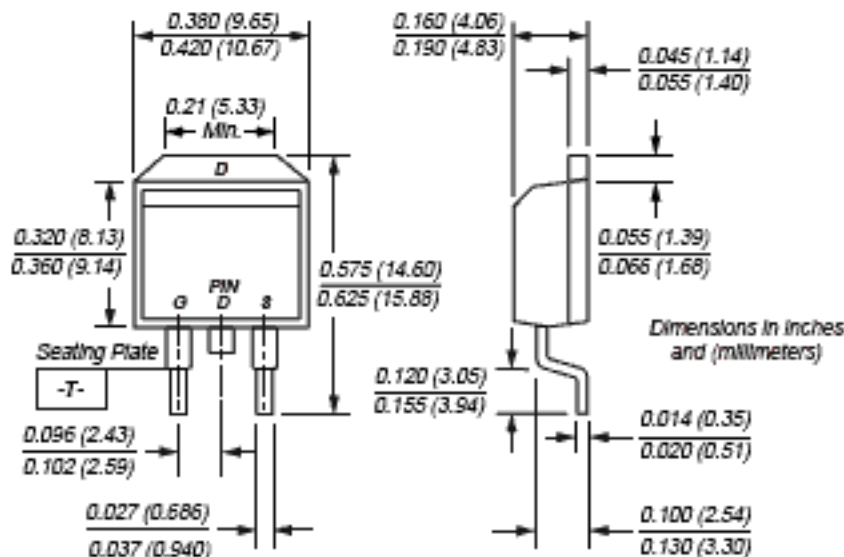

**Mechanical Data**

Case: JEDEC TO-263 molded plastic body  
 Terminals: Leads solderable per MIL-STD-750, Method 2028  
 High temperature soldering guaranteed:  
 250°C/10 seconds at terminals  
 Mounting Position: Any Weight: 1.3g

**Features**

- Advanced Trench Process Technology
- High Density Cell Design for Ultra Low On-Resistance
- Specially Designed for Low Voltage DC/DC Converters
- Fast Switching for High Efficiency

**Maximum Ratings and Thermal Characteristics** ( $T_C = 25^\circ\text{C}$  unless otherwise noted)

Parameter	Symbol	Limit	Unit
Drain-Source Voltage	$V_{DS}$	30	V
Gate-Source Voltage	$V_{GS}$	$\pm 20$	
Continuous Drain Current <sup>(1)</sup>	$I_D$	50	A
Pulsed Drain Current	$I_{DM}$	100	
Maximum Power Dissipation	$P_D$	$T_C = 25^\circ\text{C}$ 25 $T_C = 100^\circ\text{C}$	W
Operating Junction and Storage Temperature Range	$T_J, T_{stg}$	-55 to 150	$^\circ\text{C}$
Lead Temperature (1/8" from case for 5 sec.)	$T_L$	275	$^\circ\text{C}$
Junction-to-Case Thermal Resistance	$R_{\theta JC}$	2.0	$^\circ\text{C/W}$
Junction-to-Ambient Thermal Resistance <sup>(2)</sup>	$R_{\theta JA}$	40	$^\circ\text{C/W}$

Notes: (1) Maximum DC current limited by the package  
 (2) 1-In<sup>2</sup> 2oz. Cu PCB mounted

## N-Channel Enhancement-Mode MOSFET

### Electrical Characteristics (T<sub>J</sub> = 25°C unless otherwise noted)

Parameter	Symbol	Test Condition	Min	Typ	Max	Unit	
<b>Static</b>							
Drain-Source Breakdown Voltage	BV <sub>DSS</sub>	V <sub>GS</sub> = 0V, I <sub>D</sub> = 250μA	30			V	
Gate Threshold Voltage	V <sub>GS(th)</sub>	V <sub>DS</sub> = V <sub>GS</sub> , I <sub>D</sub> = 250μA	1.0		3.0		
Gate-Body Leakage	I <sub>GSS</sub>	V <sub>DS</sub> = 0V, V <sub>GS</sub> = ±20V			±100	nA	
Zero Gate Voltage Drain Current	I <sub>DSS</sub>	V <sub>DS</sub> = 30V, V <sub>GS</sub> = 0V			1	μA	
On-State Drain Current <sup>(1)</sup>	I <sub>D(on)</sub>	V <sub>DS</sub> ≥ 5V, V <sub>GS</sub> = 10V	60			A	
Drain-Source On-State Resistance <sup>(1)</sup>	R <sub>DS(on)</sub>	V <sub>GS</sub> = 10V, I <sub>D</sub> = 25A		11	13	mΩ	
		V <sub>GS</sub> = 4.5V, I <sub>D</sub> = 20A		15	20		
Forward Transconductance <sup>(1)</sup>	g <sub>fs</sub>	V <sub>DS</sub> = 10V, I <sub>D</sub> = 25A		40		S	
Diode Forward Voltage	V <sub>SD</sub>	I <sub>S</sub> = 25A, V <sub>GS</sub> = 0V		0.9	1.3	V	
<b>Dynamic<sup>(1)</sup></b>							
Total Gate Charge	Q <sub>g</sub>	V <sub>DS</sub> = 15V, V <sub>GS</sub> = 5V, I <sub>D</sub> = 50A		16	22	nC	
			V <sub>DS</sub> = 15V, V <sub>GS</sub> = 10V I <sub>D</sub> = 50A		35		60
					8		
Gate-Source Charge	Q <sub>gs</sub>	V <sub>DS</sub> = 15V, R <sub>L</sub> = 15Ω I <sub>D</sub> = 1A, V <sub>GEN</sub> = 10V R <sub>G</sub> = 6Ω		11	20	ns	
Gate-Drain Charge	Q <sub>gd</sub>			11	20		
Turn-On Delay Time	t <sub>d(on)</sub>			48	80		
Rise Time	t <sub>r</sub>		15	30			
Turn-Off Delay Time	t <sub>d(off)</sub>	V <sub>GS</sub> = 0V		–	–	pF	
Fall Time	t <sub>f</sub>		V <sub>DS</sub> = 15V		1850		–
Input Capacitance	C <sub>iss</sub>			f = 1.0MHz			–
Output Capacitance	C <sub>oss</sub>	I <sub>F</sub> = 25A, di/dt = 100A/μs		–	–	ns	
Reverse Transfer Capacitance	C <sub>rss</sub>				145		–
Source-Drain Reverse Recovery Time	t <sub>rr</sub>			160			

**Note:**

(1) Pulse test; pulse width ≤ 300 μs, duty cycle ≤ 2%

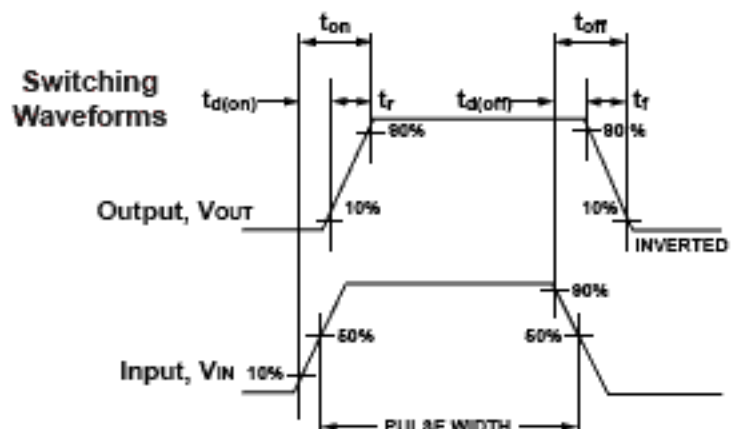
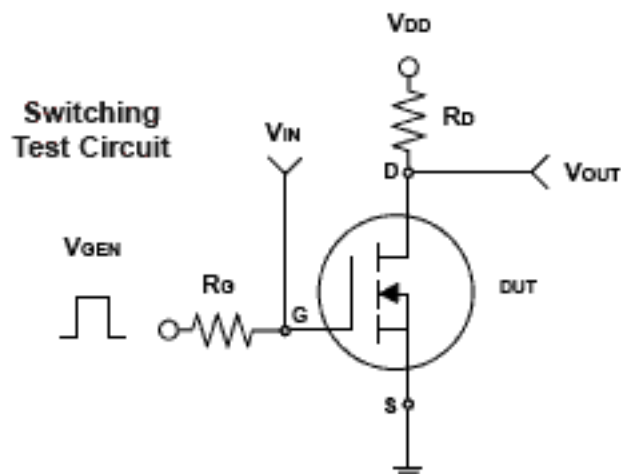

**N-Channel Enhancement-Mode MOSFET**

**Ratings and Characteristic Curves** ( $T_A = 25^\circ\text{C}$  unless otherwise noted)

**Fig. 1 – Output Characteristics**

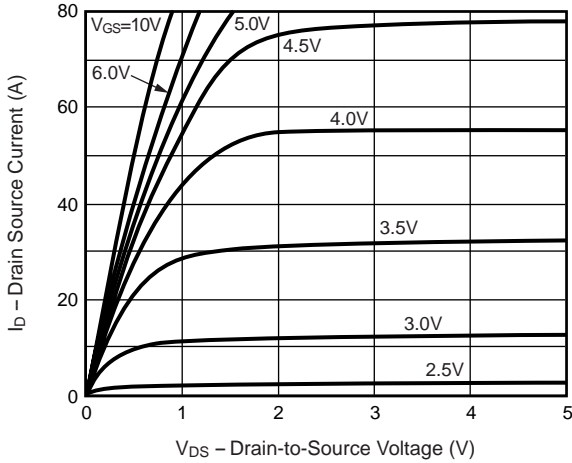

**Fig. 2 – Transfer Characteristics**

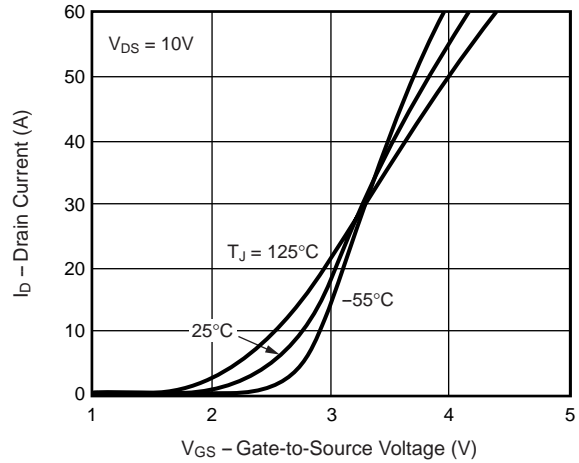

**Fig. 3 – Threshold Voltage vs. Temperature**

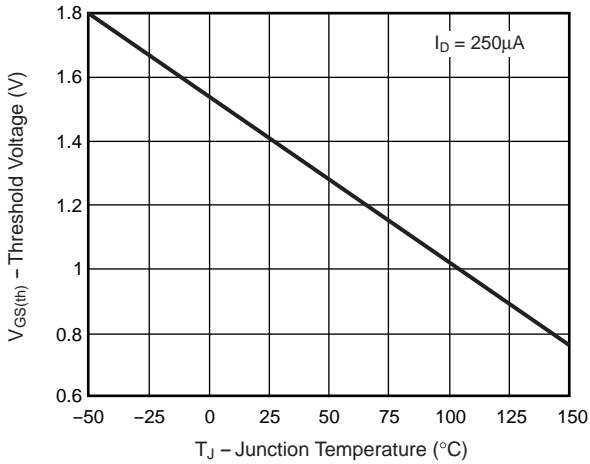

**Fig. 4 – On-Resistance vs. Drain Current**

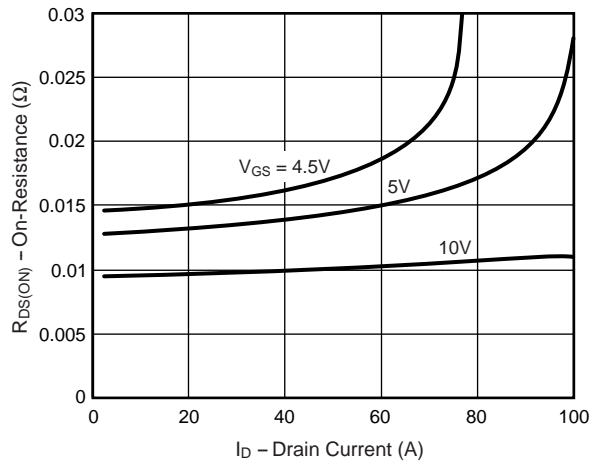

**Fig. 5 – On-Resistance vs. Junction Temperature**

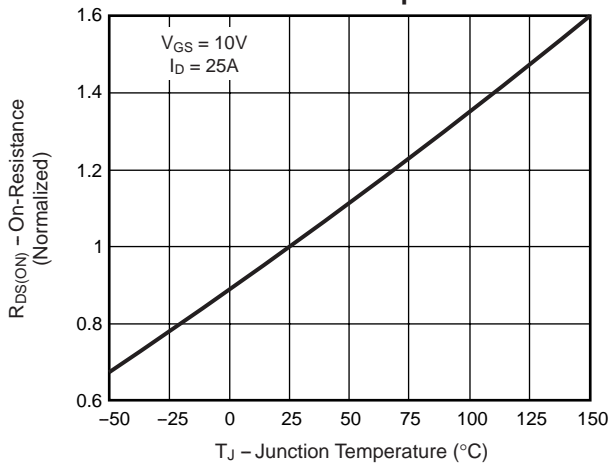

N-Channel Enhancement-Mode MOSFET

Ratings and Characteristic Curves (T<sub>A</sub> = 25°C unless otherwise noted)

Fig. 6 – On-Resistance vs. Gate-to-Source Voltage

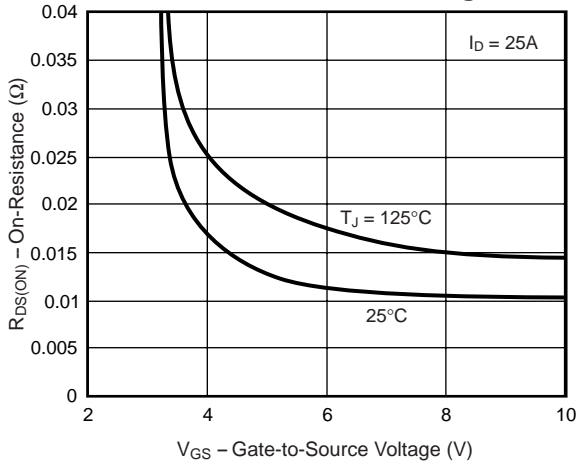

Fig. 7 – Gate Charge

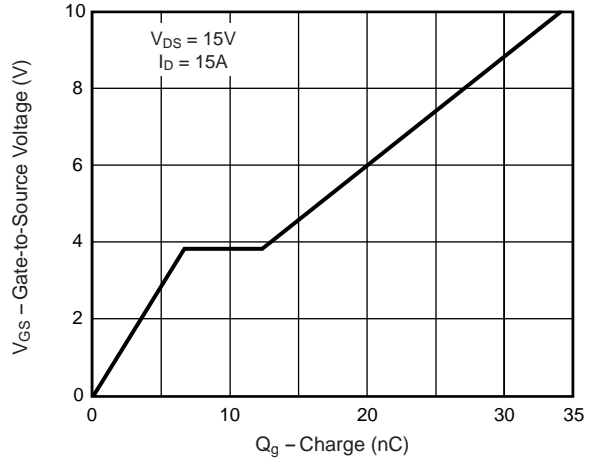

Fig. 8 – Capacitance

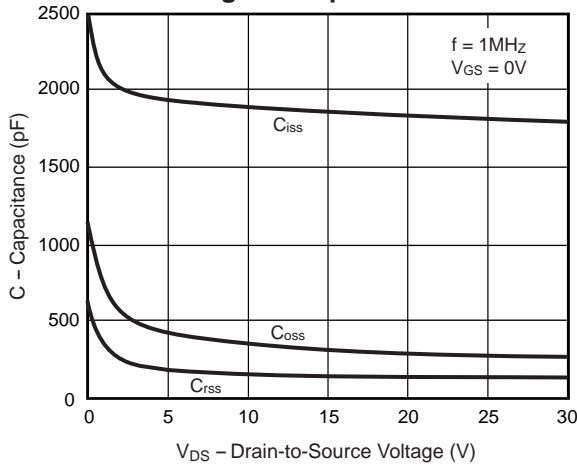
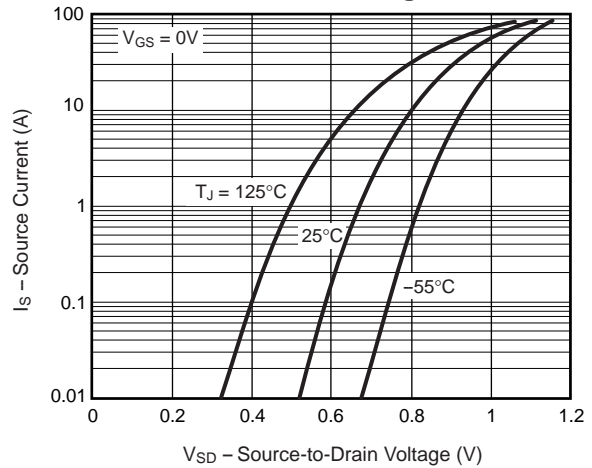

Fig. 9 – Source-Drain Diode Forward Voltage



N-Channel Enhancement-Mode MOSFET

Ratings and Characteristic Curves (T<sub>A</sub> = 25°C unless otherwise noted)

Fig. 10 – Breakdown Voltage vs. Junction Temperature

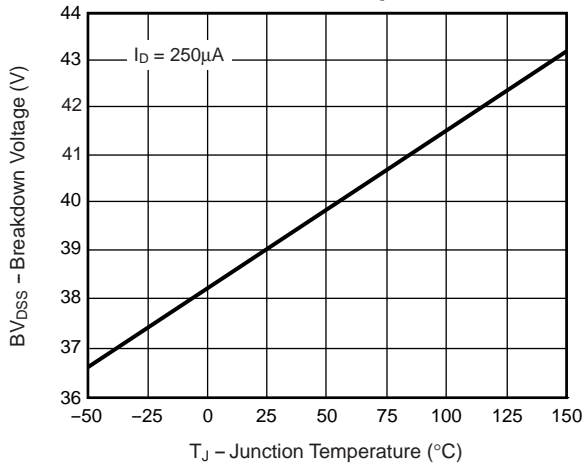

Fig. 11 – Transient Thermal Impedance

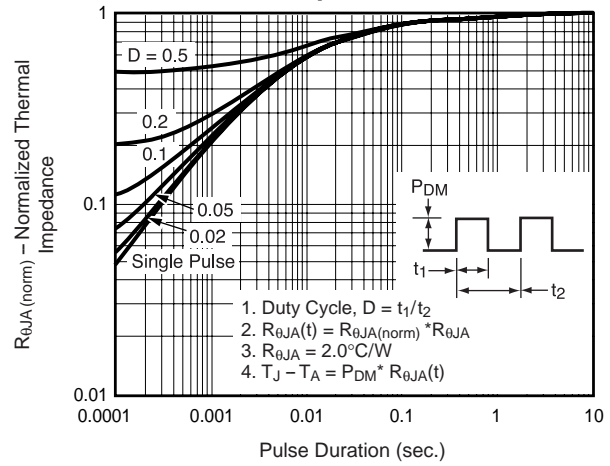

Fig. 12 – Power vs. Pulse Duration

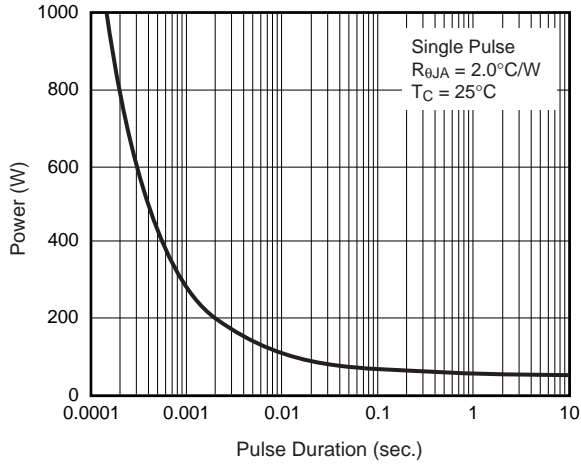

Fig. 13 – Maximum Safe Operating Area

