

### IGBT Power Module

Preliminary data

- Half-bridge
- Including fast free-wheeling diodes
- Enlarged diode area
- Package with insulated metal base plate
- $R_{G\ on, \min} = 5.6\ \text{Ohm}$

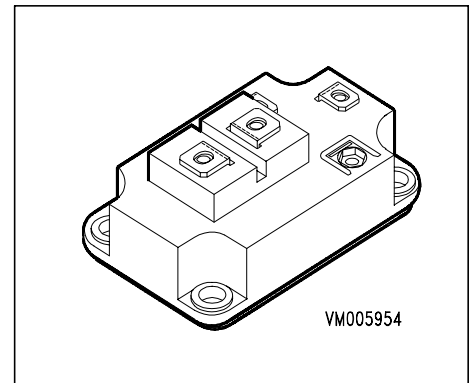

Type	$V_{CE}$	$I_C$	Package	Ordering Code
BSM300GA170DN2 E3166	1700V	440A	SINGLE SWITCH 1	C67070-A2710-A67

### Maximum Ratings

Parameter	Symbol	Values	Unit
Collector-emitter voltage	$V_{CE}$	1700	V
Collector-gate voltage	$V_{CGR}$	1700	
$R_{GE} = 20\ \text{k}\Omega$			
Gate-emitter voltage	$V_{GE}$	$\pm 20$	
DC collector current	$I_C$	440	A
$T_C = 25\ \text{°C}$			
$T_C = 80\ \text{°C}$		300	
Pulsed collector current, $t_p = 1\ \text{ms}$	$I_{C\text{puls}}$	880	
$T_C = 25\ \text{°C}$			
$T_C = 80\ \text{°C}$		600	
Power dissipation per IGBT	$P_{\text{tot}}$	2500	W
$T_C = 25\ \text{°C}$			
Chip temperature	$T_j$	+ 150	°C
Storage temperature	$T_{\text{stg}}$	-55 ... + 150	
Thermal resistance, chip case	$R_{\text{thJC}}$	$\leq 0.05$	K/W
Diode thermal resistance, chip case	$R_{\text{thJCD}}$	$\leq 0.1$	
Insulation test voltage, $t = 1\ \text{min.}$	$V_{\text{is}}$	4000	Vac
Creepage distance	-	20	mm
Clearance	-	11	
DIN humidity category, DIN 40 040	-	F	-
IEC climatic category, DIN IEC 68-1	-	55 / 150 / 56	

**Electrical Characteristics**, at  $T_j = 25\text{ °C}$ , unless otherwise specified

Parameter	Symbol	Values			Unit
		min.	typ.	max.	

**Static Characteristics**

Gate threshold voltage $V_{GE} = V_{CE}, I_C = 20\text{ mA}$	$V_{GE(th)}$	4.8	5.5	6.2	V
Collector-emitter saturation voltage $V_{GE} = 15\text{ V}, I_C = 300\text{ A}, T_j = 25\text{ °C}$ $V_{GE} = 15\text{ V}, I_C = 300\text{ A}, T_j = 125\text{ °C}$	$V_{CE(sat)}$	- -	3.4 4.6	3.9 5.3	
Zero gate voltage collector current $V_{CE} = 1700\text{ V}, V_{GE} = 0\text{ V}, T_j = 25\text{ °C}$ $V_{CE} = 1700\text{ V}, V_{GE} = 0\text{ V}, T_j = 125\text{ °C}$	$I_{CES}$	- -	2 8	3 -	mA
Gate-emitter leakage current $V_{GE} = 20\text{ V}, V_{CE} = 0\text{ V}$	$I_{GES}$	-	-	400	nA

**AC Characteristics**

Transconductance $V_{CE} = 20\text{ V}, I_C = 300\text{ A}$	$g_{fs}$	108	-	-	S
Input capacitance $V_{CE} = 25\text{ V}, V_{GE} = 0\text{ V}, f = 1\text{ MHz}$	$C_{iss}$	-	44	-	nF
Output capacitance $V_{CE} = 25\text{ V}, V_{GE} = 0\text{ V}, f = 1\text{ MHz}$	$C_{oss}$	-	3.5	-	
Reverse transfer capacitance $V_{CE} = 25\text{ V}, V_{GE} = 0\text{ V}, f = 1\text{ MHz}$	$C_{rss}$	-	1	-	

### Electrical Characteristics, at $T_j = 25\text{ °C}$ , unless otherwise specified

Parameter	Symbol	Values			Unit
		min.	typ.	max.	

### Switching Characteristics, Inductive Load at $T_j = 125\text{ °C}$

Turn-on delay time $V_{CC} = 1200\text{ V}$ , $V_{GE} = 15\text{ V}$ , $I_C = 300\text{ A}$ $R_{Gon} = 5.6\ \Omega$	$t_{d(on)}$	-	600	1200	ns
Rise time $V_{CC} = 1200\text{ V}$ , $V_{GE} = 15\text{ V}$ , $I_C = 300\text{ A}$ $R_{Gon} = 5.6\ \Omega$	$t_r$	-	200	400	
Turn-off delay time $V_{CC} = 1200\text{ V}$ , $V_{GE} = -15\text{ V}$ , $I_C = 300\text{ A}$ $R_{Goff} = 5.6\ \Omega$	$t_{d(off)}$	-	1280	1900	
Fall time $V_{CC} = 1200\text{ V}$ , $V_{GE} = -15\text{ V}$ , $I_C = 300\text{ A}$ $R_{Goff} = 5.6\ \Omega$	$t_f$	-	110	160	

### Free-Wheel Diode

Diode forward voltage $I_F = 300\text{ A}$ , $V_{GE} = 0\text{ V}$ , $T_j = 25\text{ °C}$ $I_F = 300\text{ A}$ , $V_{GE} = 0\text{ V}$ , $T_j = 125\text{ °C}$	$V_F$	-	2 1.8	2.5 -	V
Reverse recovery time $I_F = 300\text{ A}$ , $V_R = -1200\text{ V}$ , $V_{GE} = 0\text{ V}$ $di_F/dt = -1500\text{ A}/\mu\text{s}$ , $T_j = 125\text{ °C}$	$t_{rr}$	-	1	-	
Reverse recovery charge $I_F = 300\text{ A}$ , $V_R = -1200\text{ V}$ , $V_{GE} = 0\text{ V}$ $di_F/dt = -1500\text{ A}/\mu\text{s}$ $T_j = 25\text{ °C}$ $T_j = 125\text{ °C}$	$Q_{rr}$	-	28 100	- -	$\mu\text{C}$

### Power dissipation

$$P_{\text{tot}} = f(T_C)$$

parameter:  $T_j \leq 150^\circ\text{C}$

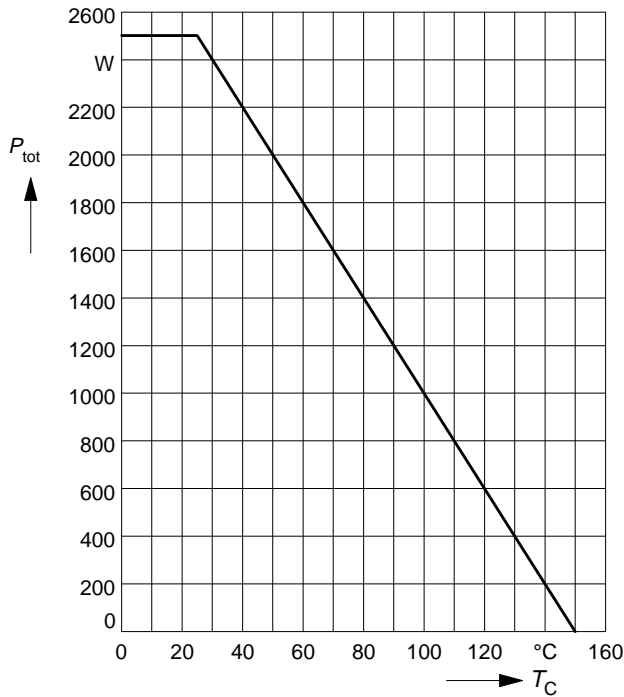

### Safe operating area

$$I_C = f(V_{CE})$$

parameter:  $D = 0, T_C = 25^\circ\text{C}, T_j \leq 150^\circ\text{C}$

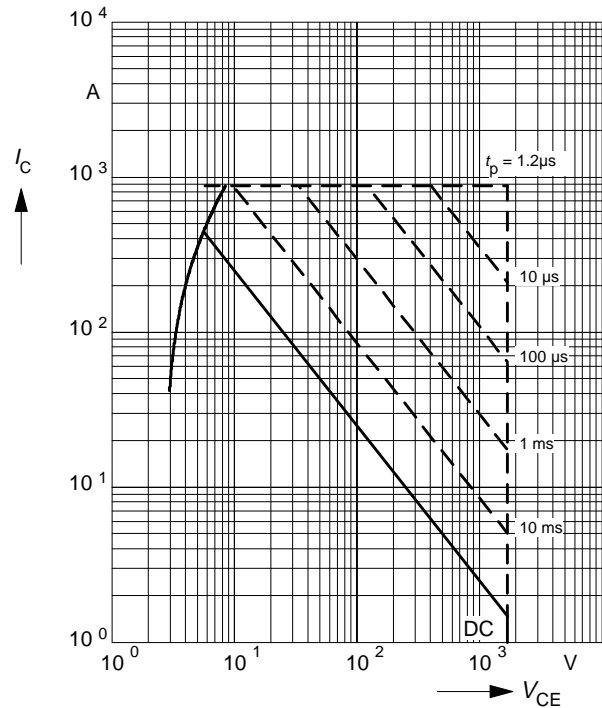

### Collector current

$$I_C = f(T_C)$$

parameter:  $V_{GE} \geq 15\text{ V}, T_j \leq 150^\circ\text{C}$

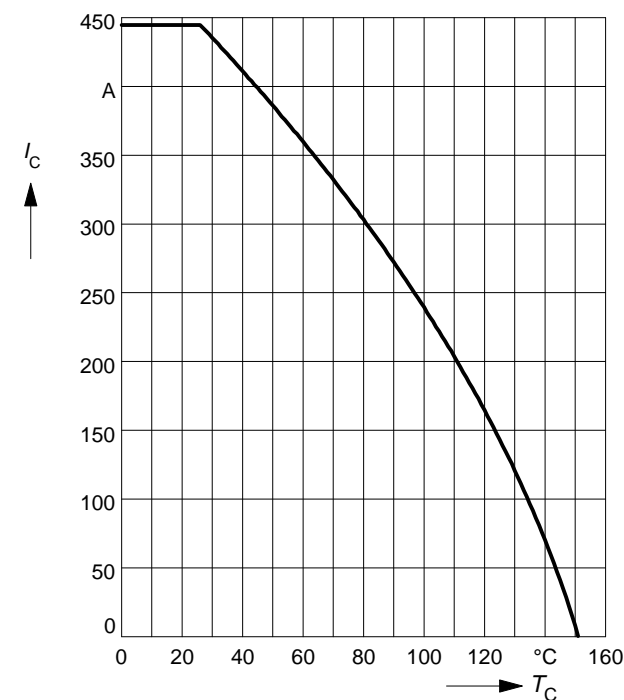

### Transient thermal impedance IGBT

$$Z_{\text{thJC}} = f(t_p)$$

parameter:  $D = t_p / T$

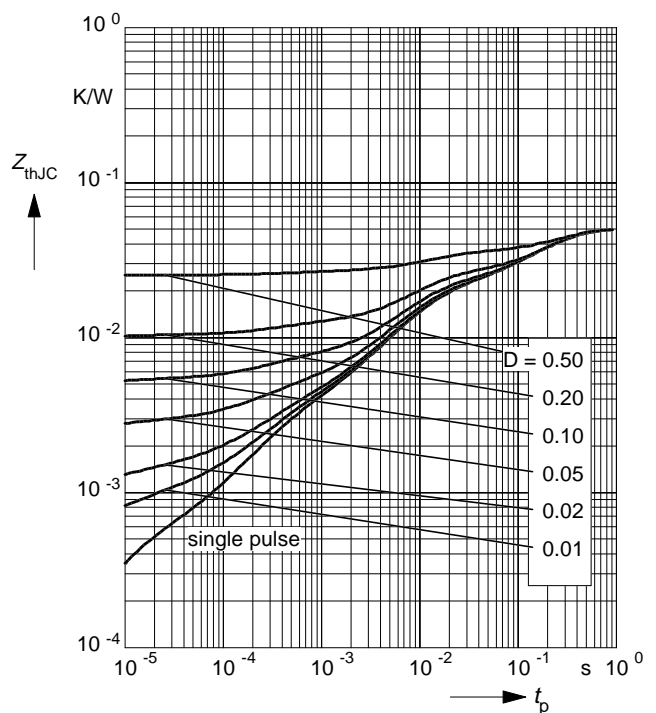

### Typ. output characteristics

$$I_C = f(V_{CE})$$

parameter:  $t_p = 80 \mu s$ ,  $T_j = 25^\circ C$

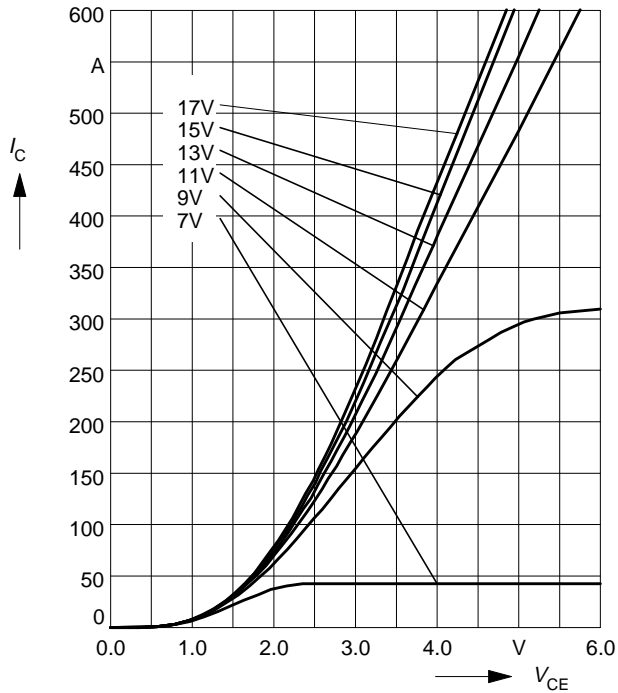

### Typ. output characteristics

$$I_C = f(V_{CE})$$

parameter:  $t_p = 80 \mu s$ ,  $T_j = 125^\circ C$

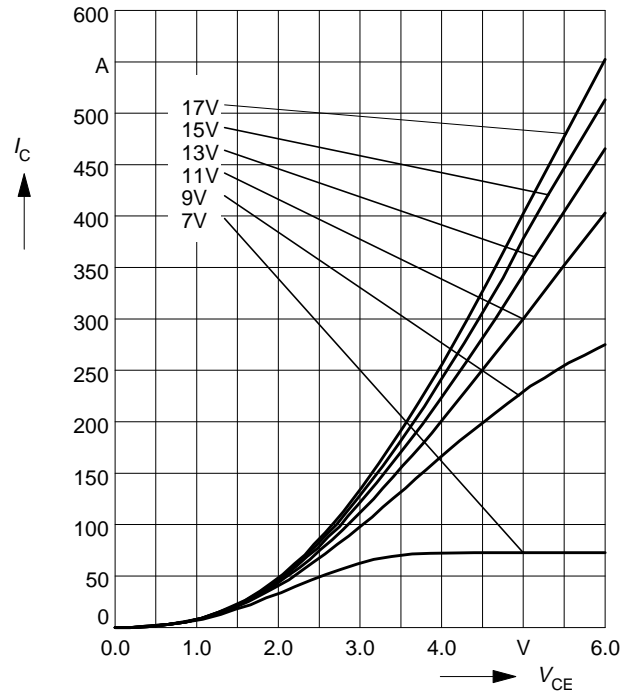

### Typ. transfer characteristics

$$I_C = f(V_{GE})$$

parameter:  $t_p = 80 \mu s$ ,  $V_{CE} = 20 V$

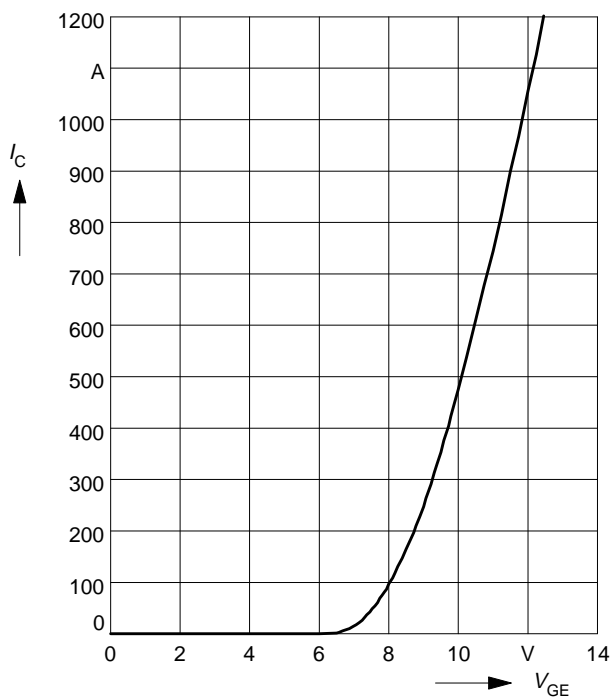

### Typ. gate charge

$$V_{GE} = f(Q_{Gate})$$

parameter:  $I_{C\ puls} = 300\text{ A}$

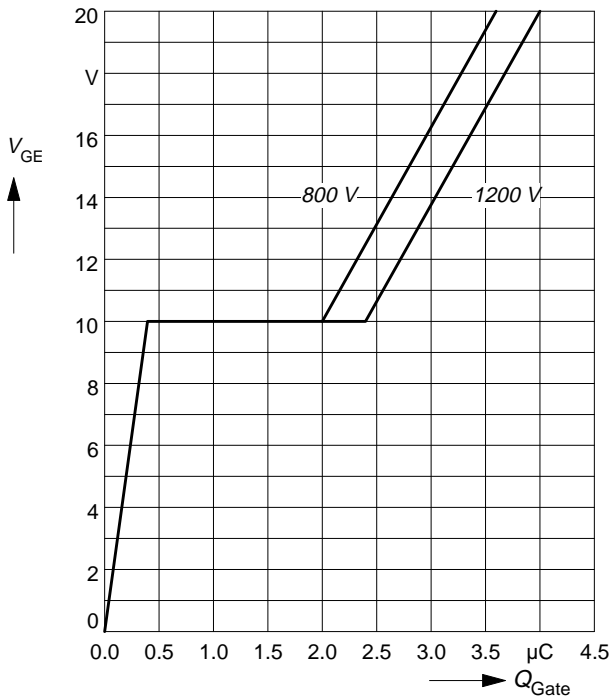

### Typ. capacitances

$$C = f(V_{CE})$$

parameter:  $V_{GE} = 0, f = 1\text{ MHz}$

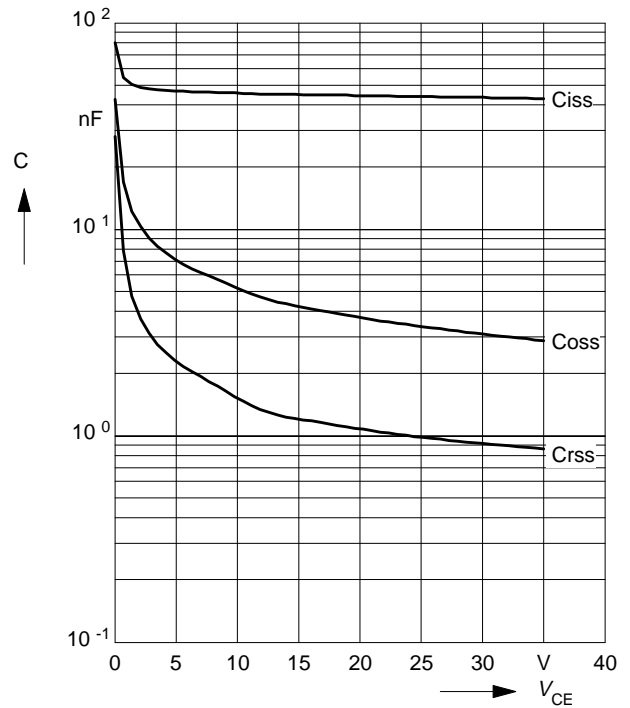

### Reverse biased safe operating area

$$I_{C\ puls} = f(V_{CE}), T_j = 150^\circ\text{C}$$

parameter:  $V_{GE} = 15\text{ V}$

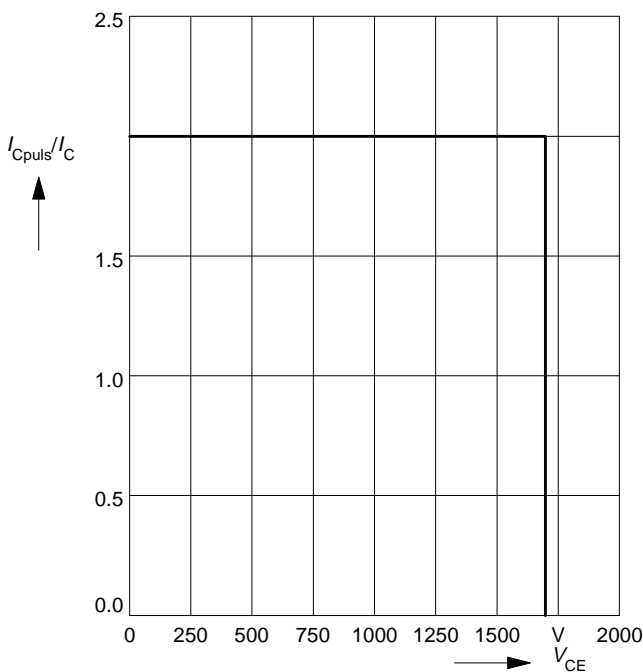

### Short circuit safe operating area

$$I_{C\ sc} = f(V_{CE}), T_j = 150^\circ\text{C}$$

parameter:  $V_{GE} = \pm 15\text{ V}, t_{SC} \leq 10\ \mu\text{s}, L < 20\text{ nH}$

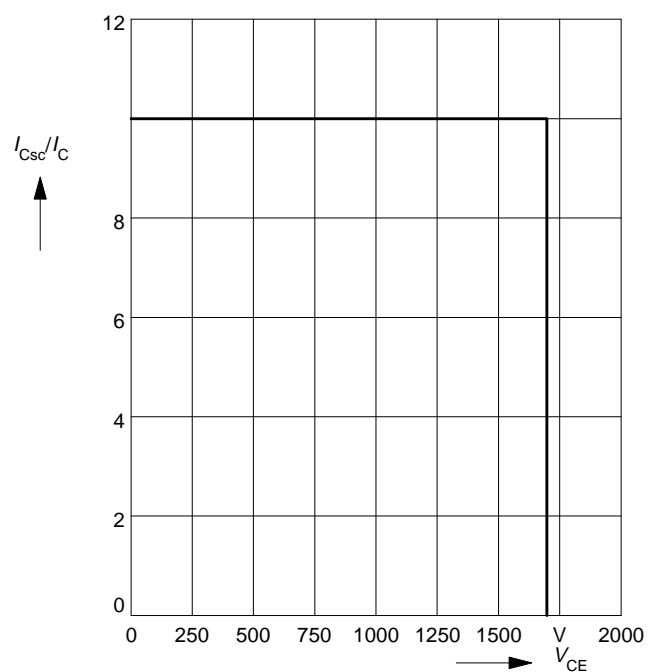

### Typ. switching time

$t = f(I_C)$ , inductive load,  $T_j = 125^\circ\text{C}$   
 par.:  $V_{CE} = 1200\text{ V}$ ,  $V_{GE} = \pm 15\text{ V}$ ,  $R_G = 5.6\ \Omega$

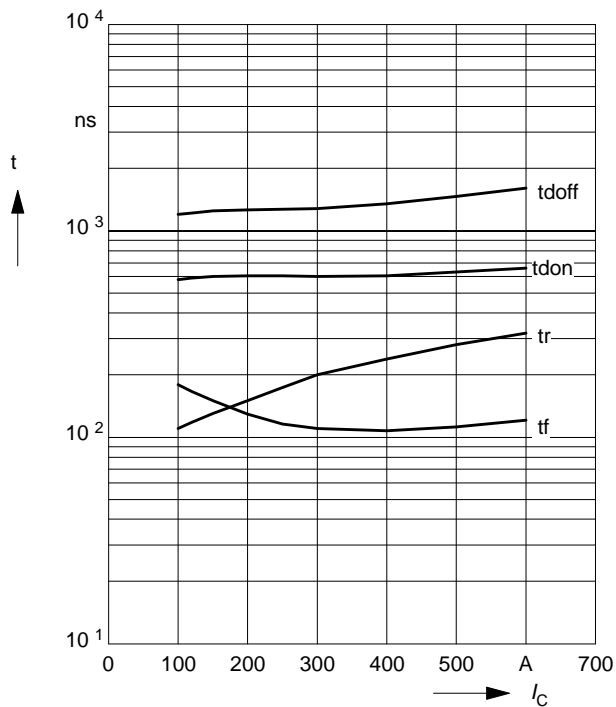

### Typ. switching time

$t = f(R_G)$ , inductive load,  $T_j = 125^\circ\text{C}$   
 par.:  $V_{CE} = 1200\text{ V}$ ,  $V_{GE} = \pm 15\text{ V}$ ,  $I_C = 300\text{ A}$

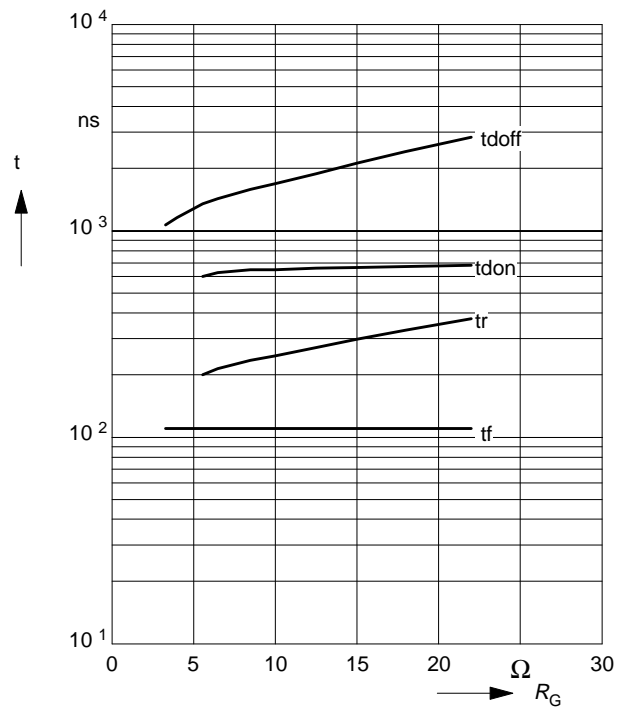

### Typ. switching losses

$E = f(I_C)$ , inductive load,  $T_j = 125^\circ\text{C}$   
 par.:  $V_{CE} = 1200\text{ V}$ ,  $V_{GE} = \pm 15\text{ V}$ ,  $R_G = 5.6\ \Omega$

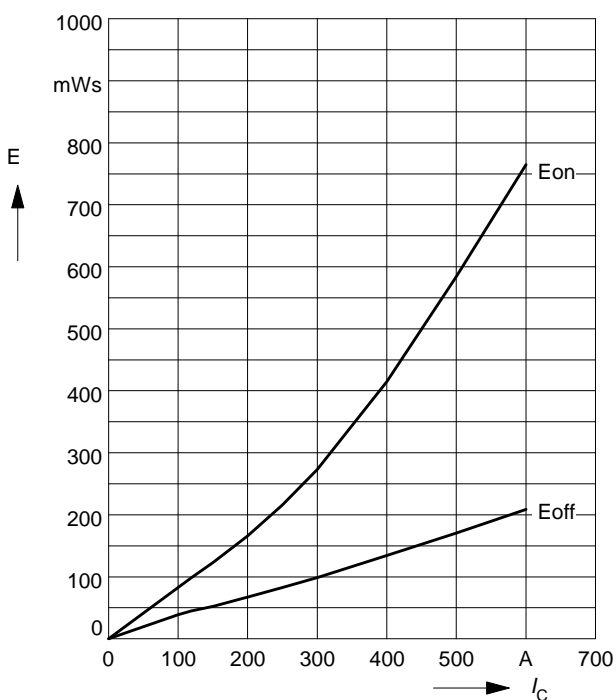

### Typ. switching losses

$E = f(R_G)$ , inductive load,  $T_j = 125^\circ\text{C}$   
 par.:  $V_{CE} = 1200\text{ V}$ ,  $V_{GE} = \pm 15\text{ V}$ ,  $I_C = 300\text{ A}$

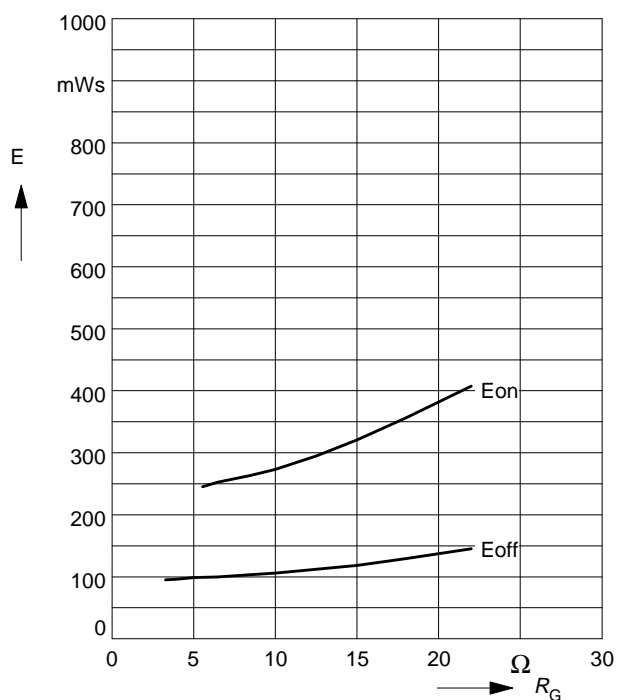

### Forward characteristics of fast recovery reverse diode

$I_F = f(V_F)$

parameter:  $T_j$

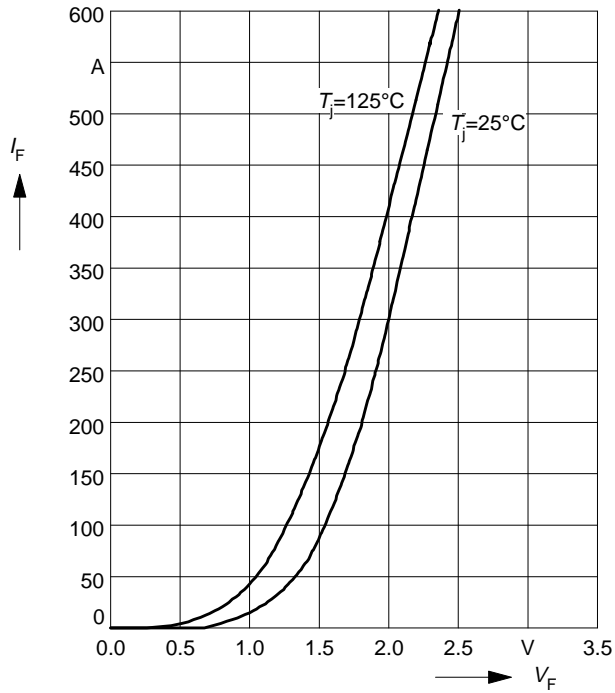

### Transient thermal impedance Diode

$Z_{thJC} = f(t_p)$

parameter:  $D = t_p / T$

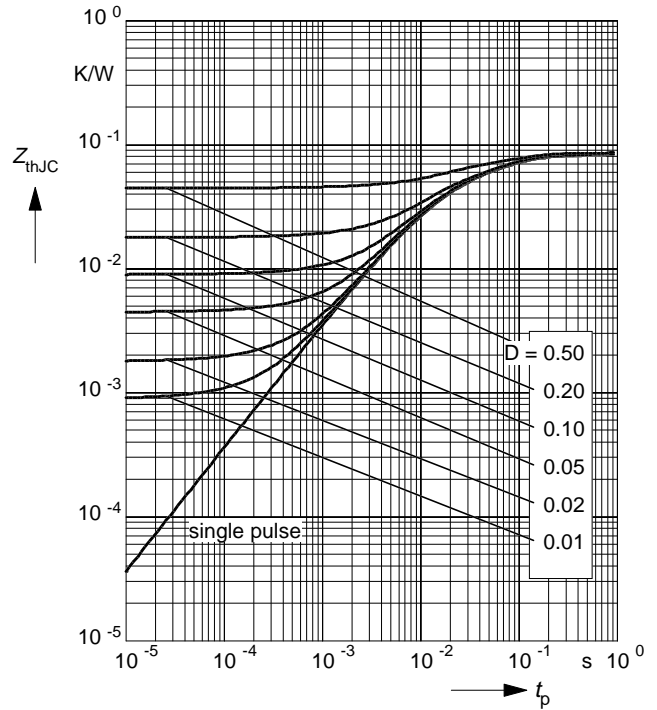



### Circuit Diagram

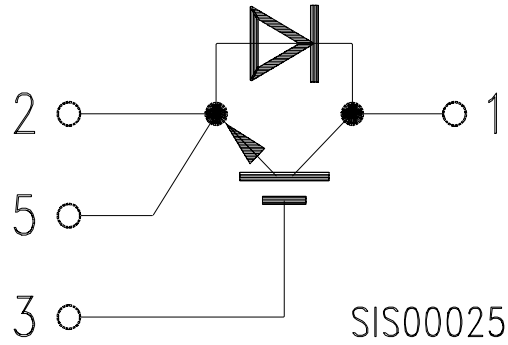

### Package Outlines

Dimensions in mm

Weight: 420 g

