

## GaAs InGaP HBT MMIC POWER AMPLIFIER, 2.2 - 2.8 GHz

### Typical Applications

This amplifier is ideal for use as a power amplifier for 2.2 - 2.7 GHz applications:

- BLUETOOTH
- MMDS

### Features

- Gain: 20 dB
- Saturated Power: +30 dBm
- 32% PAE
- Supply Voltage: +2.75V to +5.0 V
- Power Down Capability
- Low External Part Count

### Functional Diagram

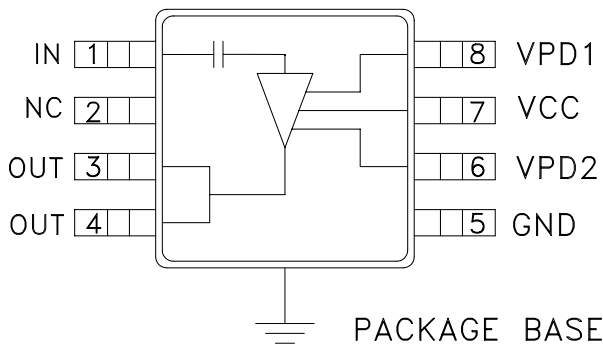

### General Description

The HMC414MS8G is a high efficiency GaAs InGaP Heterojunction Bipolar Transistor (HBT) MMIC Power amplifier which operates between 2.2 and 2.8 GHz. The amplifier is packaged in a low cost, surface mount 8 leaded package with an exposed base for improved RF and thermal performance. With a minimum of external components, the amplifier provides 20 dB of gain, +30 dBm of saturated power at 32% PAE from a +5.0V supply voltage. The amplifier can also operate with a 3.6V supply. Vpd can be used for full power down or RF output power/current control.

### Electrical Specifications, $T_A = +25^\circ C$ , As a Function of $V_s$ , $V_{pd} = 3.6V$

Parameter	$V_s = 3.6V$			$V_s = 5.0V$			Units
	Min.	Typ.	Max.	Min.	Typ.	Max.	
Frequency Range	2.2 - 2.8			2.2 - 2.8			GHz
Gain	17	20	25	17	20	25	dB
Gain Variation Over Temperature		0.03	0.04		0.03	0.04	dB/ °C
Input Return Loss		8			8		dB
Output Return Loss		9			9		dB
Output Power for 1 dB Compression (P1dB)	21	25		23	27		dBm
Saturated Output Power (Psat)		27			30		dBm
Output Third Order Intercept (IP3)	30	35		35	39		dBm
Noise Figure		6.5			7.0		dB
Supply Current (Icq)	$V_{pd} = 0V / 3.6V$		0.002 / 240	$V_{pd} = 0V / 5.0V$		0.002 / 300	mA
Control Current (Ipd)	$V_{pd} = 3.6V$		7	$V_{pd} = 5.0V$		7	mA
Switching Speed	tON, tOFF		45	tON, tOFF		45	ns

## GaAs InGaP HBT MMIC POWER AMPLIFIER, 2.2 - 2.8 GHz

Gain vs. Temperature,  $V_s = 3.6V$

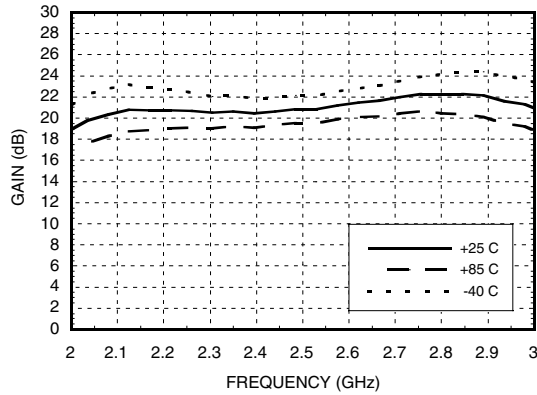

Gain vs. Temperature,  $V_s = 5.0V$

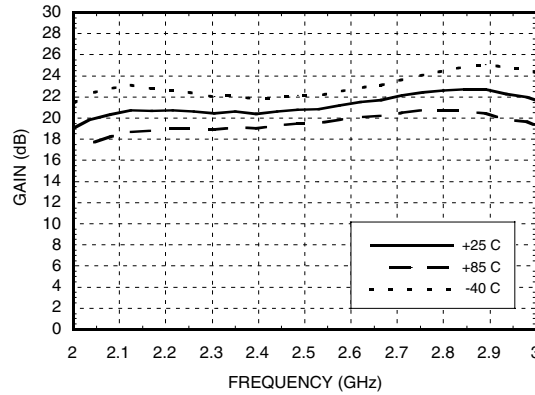

Return Loss,  $V_s = 3.6V$

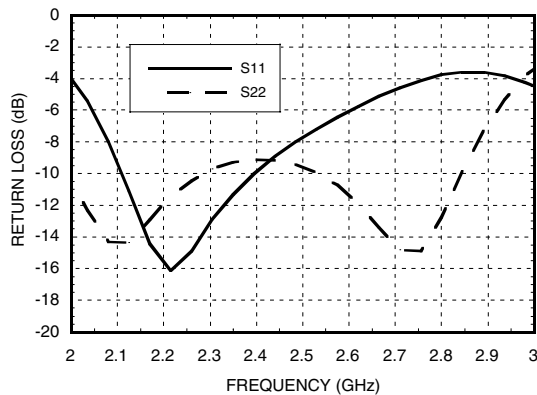

Return Loss,  $V_s = 5.0V$

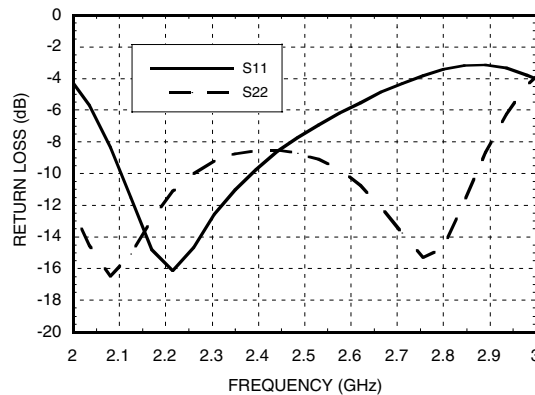

P1dB vs. Temperature,  $V_s = 3.6V$

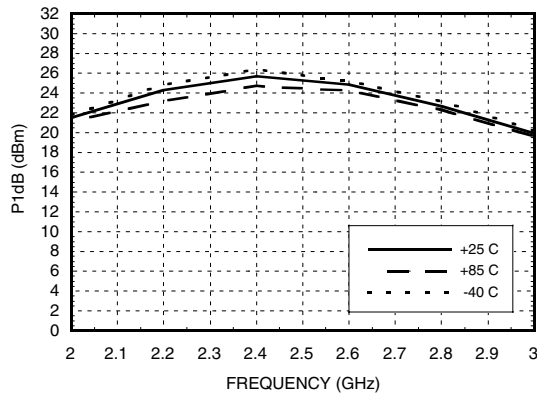

P1dB vs. Temperature,  $V_s = 5.0V$

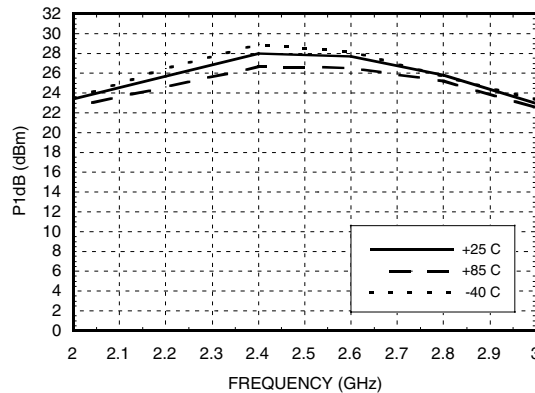

## GaAs InGaP HBT MMIC POWER AMPLIFIER, 2.2 - 2.8 GHz

8

AMPLIFIERS - SMT

**Psat vs. Temperature, Vs= 3.6V**

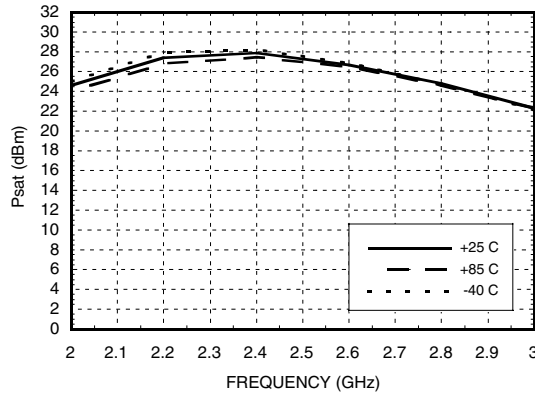

**Psat vs. Temperature, Vs= 5.0V**

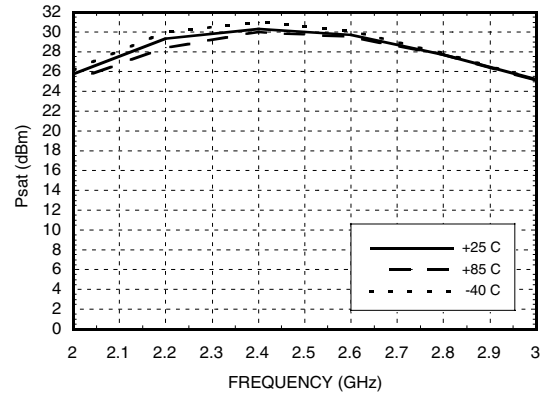

**Power Compression@ 2.4 GHz, Vs= 3.6V**

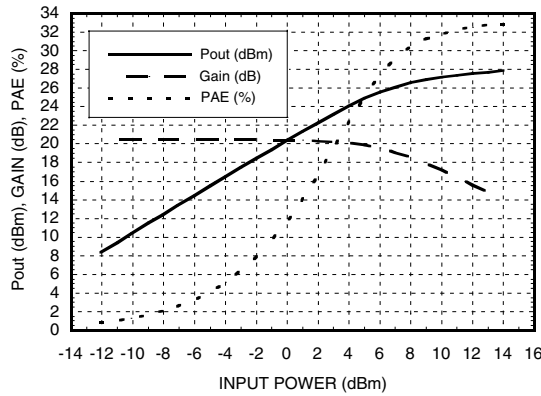

**Power Compression@ 2.4 GHz, Vs= 5.0V**

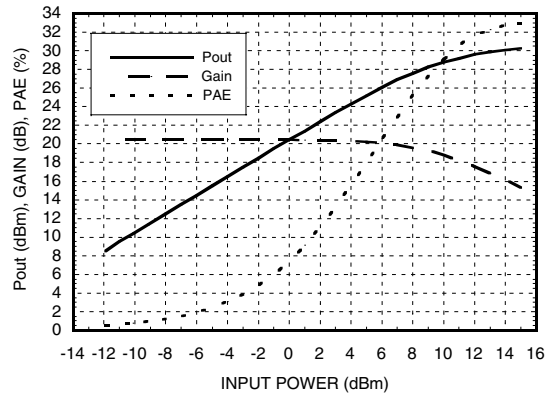

**Output IP3 vs. Temperature, Vs= 3.6V**

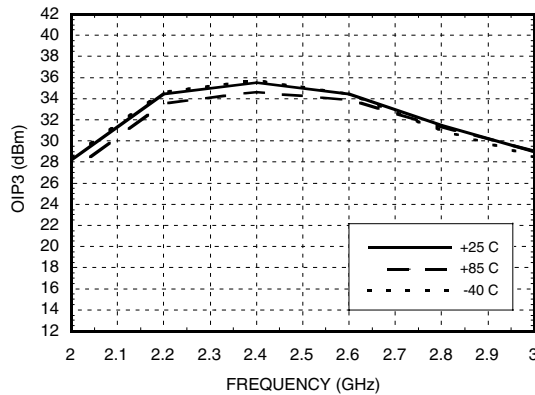

**Output IP3 vs. Temperature, Vs= 5.0V**

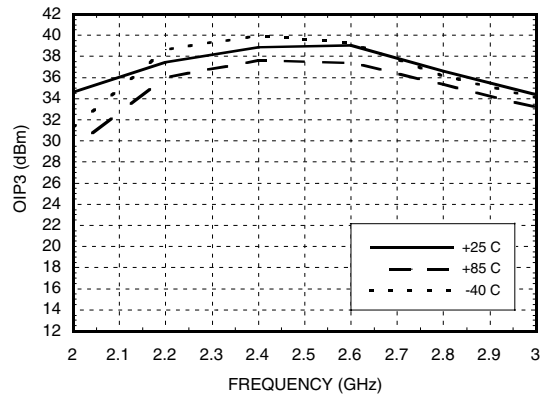

## GaAs InGaP HBT MMIC POWER AMPLIFIER, 2.2 - 2.8 GHz

**Reverse Isolation vs. Temperature, Vs= 3.6V**

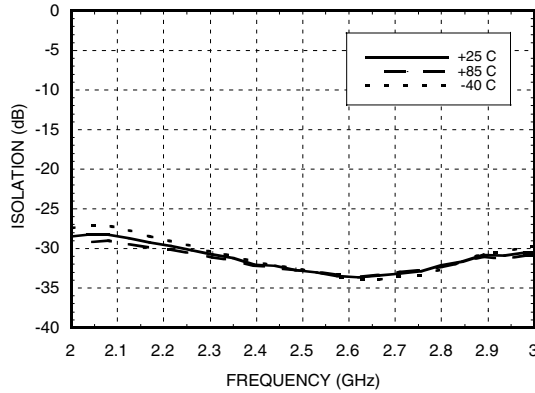

**Power Down Isolation, Vs= 3.6V**

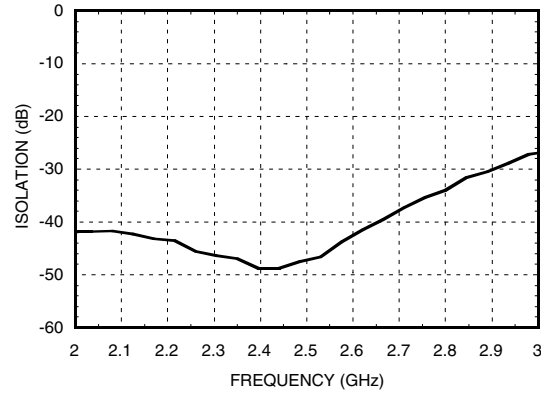

**Noise Figure vs. Temperature, Vs= 3.6V**

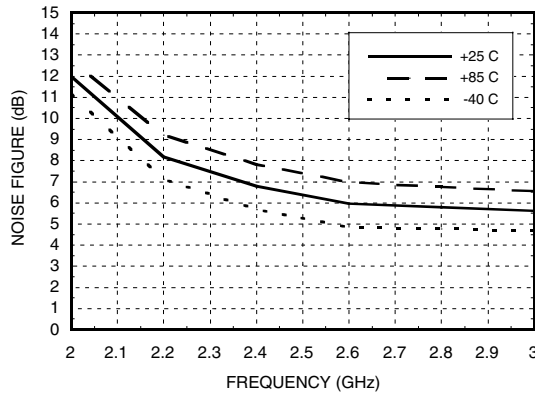

**Noise Figure vs. Temperature, Vs= 5.0V**

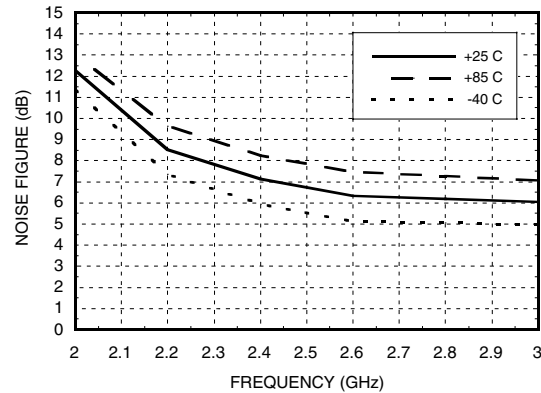

**Gain & Power vs. Supply Voltage**

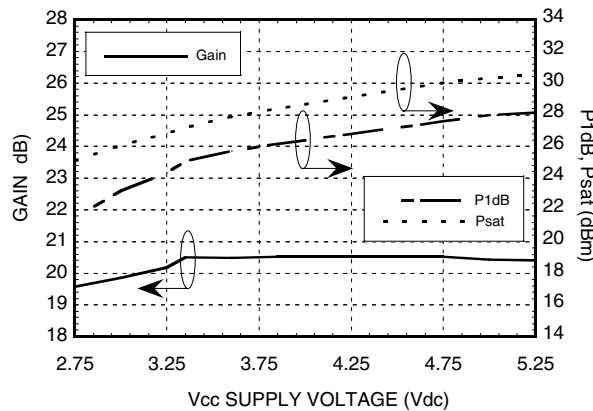

**Gain, Power & Quiescent Supply Current vs Vpd @ 2.4 GHz**

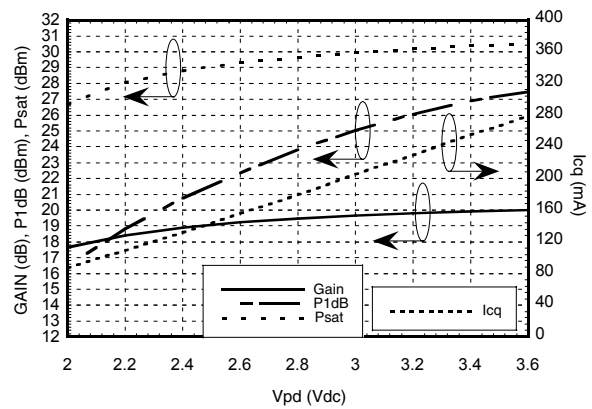

## GaAs InGaP HBT MMIC POWER AMPLIFIER, 2.2 - 2.8 GHz

### Absolute Maximum Ratings

Collector Bias Voltage (Vcc)	+5.5 Vdc
Control Voltage (Vpd1, Vpd2)	+4.0 Vdc
RF Input Power (RFIn)(Vs = +5.0, Vpd = +3.6 Vdc)	+20 dBm
Junction Temperature	150 °C
Continuous Pdiss (T = 85 °C) (derate 27 mW/°C above 85 °C)	1.755 W
Thermal Resistance (junction to ground paddle)	37 °C/W
Storage Temperature	-65 to +150 °C
Operating Temperature	-40 to +85 °C

### Outline Drawing

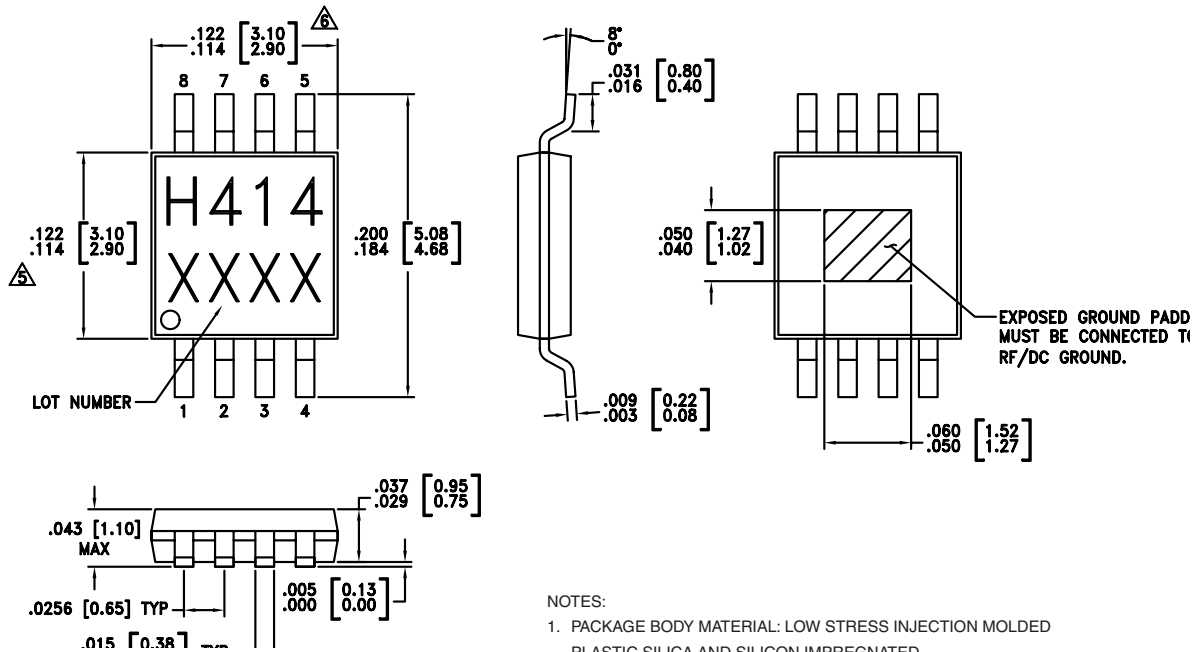



NOTES:

1. PACKAGE BODY MATERIAL: LOW STRESS INJECTION MOLDED PLASTIC SILICA AND SILICON IMPREGNATED.
2. LEADFRAME MATERIAL: COPPER ALLOY
3. LEADFRAME PLATING: Sn/Pb SOLDER
4. DIMENSIONS ARE IN INCHES [MILLIMETERS].
5. DIMENSION DOES NOT INCLUDE MOLDFLASH OF 0.15mm PER SIDE.
6. DIMENSION DOES NOT INCLUDE MOLDFLASH OF 0.25mm PER SIDE.
7. ALL GROUND LEADS AND GROUND PADDLE MUST BE SOLDERED TO PCB RF GROUND.

## GaAs InGaP HBT MMIC POWER AMPLIFIER, 2.2 - 2.8 GHz

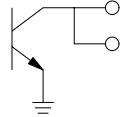
### Pin Descriptions

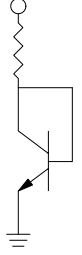
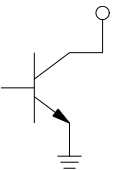
Pin Number	Function	Description	Interface Schematic
1	RF IN	This pin is AC coupled and matched to 50 Ohms from 2.2 to 2.8 GHz.	
2	NC	Not Connected.	
3, 4	RF OUT	RF output and DC bias for the output stage.	
5	GND	Ground: Backside of package has exposed metal ground slug that must be connected to ground thru a short path. Vias under the device are required.	
6, 8	Vpd1, Vpd2	Power control pin. For maximum power, this pin should be connected to 3.6V. For 5V operation, a dropping resistor is required. A higher voltage is not recommended. For lower idle current, this voltage can be reduced.	
7	Vcc	Power supply voltage for the first amplifier stage. An external bypass capacitor of 330 pF is required as shown in the application schematic.	

### Evaluation PCB

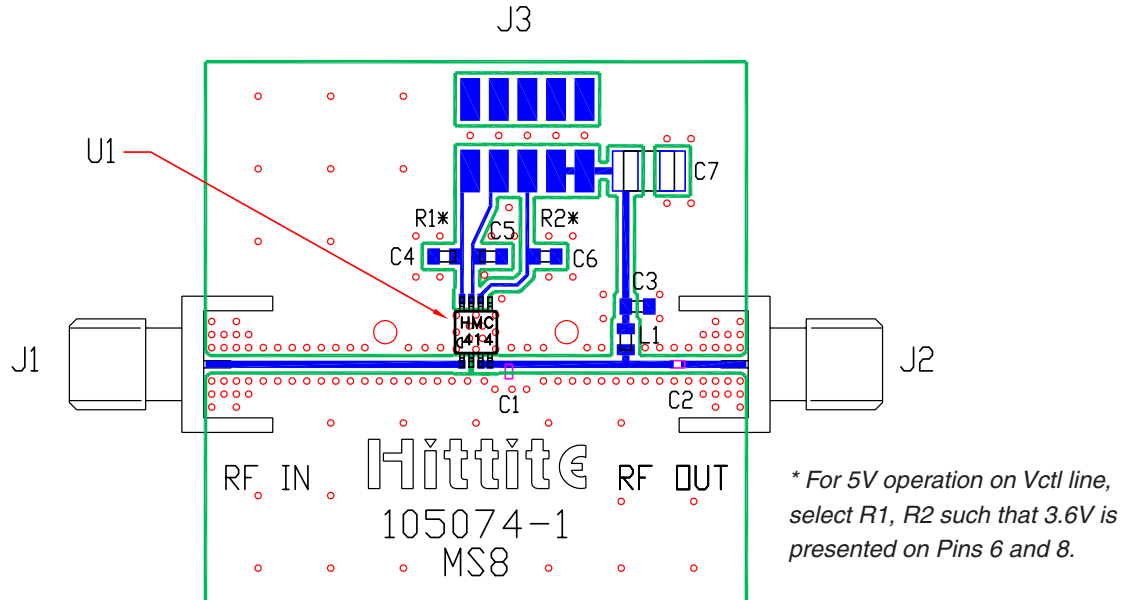

### List of Material

Item	Description
J1 - J2	PC Mount SMA RF Connector
J3	2 mm DC Header
C1	2.7 pF Capacitor, 0603 Pkg.
C2	100 pF Capacitor, 0402 Pkg.
C3 - C6	330 pF Capacitor, 0603 Pkg.
C7	2.2 $\mu$ F Capacitor, Tantalum
L1	18nH Inductor 0603 Pkg.
U1	HMC414MS8G Amplifier
PCB*	105074 Eval Board

\* Circuit Board Material: Rogers 4350

The circuit board used in the final application should use RF circuit design techniques. Signal lines should have 50 ohm impedance while the package ground leads and exposed paddle should be connected directly to the ground plane similar to that shown. A sufficient number of VIA holes should be used to connect the top and bottom ground planes. The evaluation board should be mounted to an appropriate heat sink. The evaluation circuit board shown is available from Hittite upon request.

## GaAs InGaP HBT MMIC POWER AMPLIFIER, 2.2 - 2.8 GHz

### Application Circuit

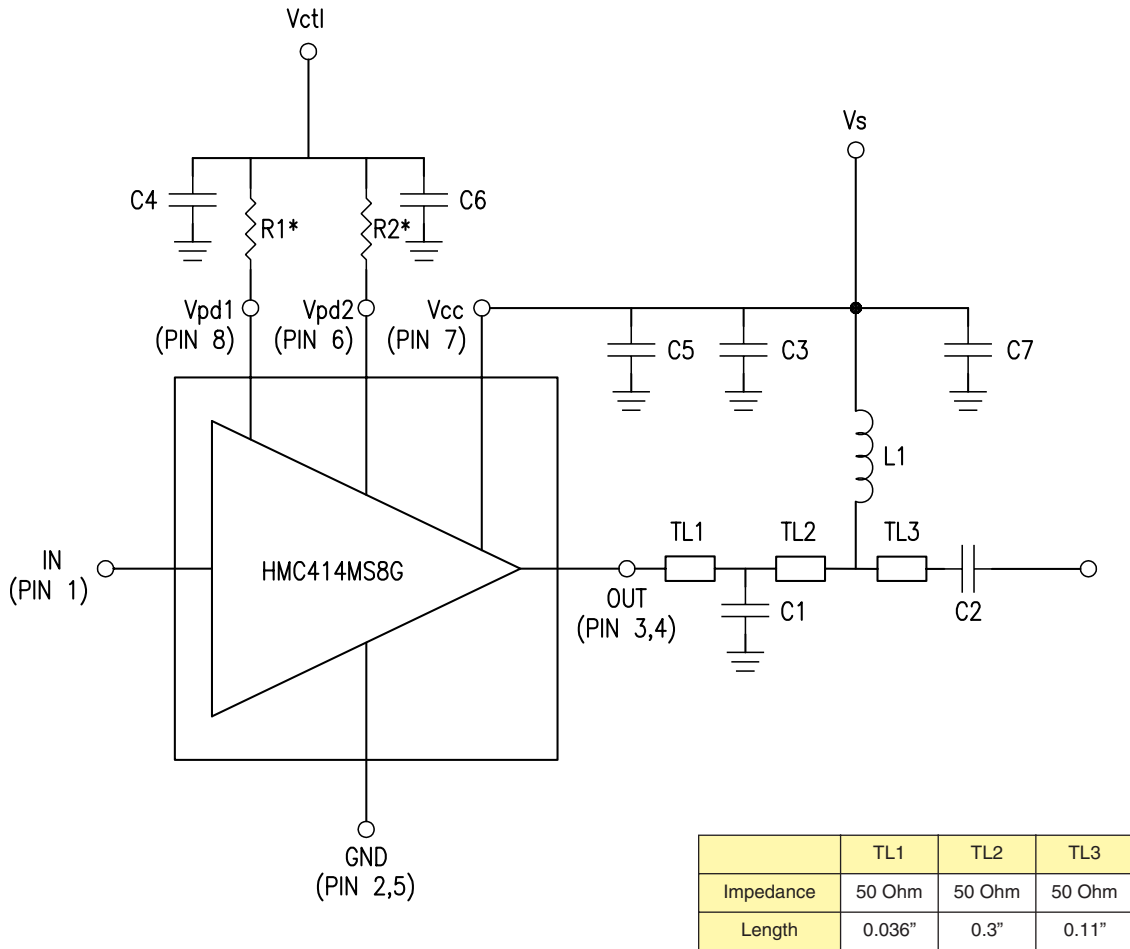

\* For 5V operation on Vctl line, select R1, R2 such that 3.6V is presented on Pins 6 and 8.