

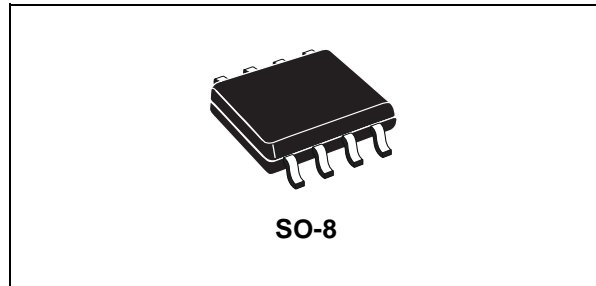

# STS2DPFS20V

## P-CHANNEL 20V - 0.14 $\Omega$ - 2.5A SO-8 2.7V-DRIVE STripFET™ II MOSFET PLUS SCHOTTKY DIODE

MAIN PRODUCT CHARACTERISTICS			
MOSFET	V <sub>DSS</sub>	R <sub>DS(on)</sub>	I <sub>D</sub>
	20 V	< 0.20 $\Omega$ (@4.5V) < 0.25 $\Omega$ (@2.7V)	2.5 A
SCHOTTKY	I <sub>F(AV)</sub>	V <sub>RRM</sub>	V <sub>F(MAX)</sub>
	3 A	30 V	0.51 V



### DESCRIPTION

This product associates the latest low voltage StripFETœ in p-channel version to a low drop Schottky diode. Such configuration is extremely versatile in implementing, a large variety of DC-DC converters for printers, portable equipment, and cellular phones.

### INTERNAL SCHEMATIC DIAGRAM

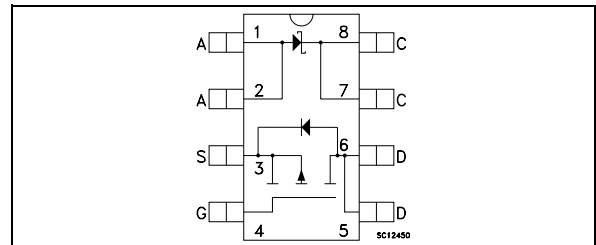

### MOSFET ABSOLUTE MAXIMUM RATINGS

Symbol	Parameter	Value	Unit
V <sub>DS</sub>	Dain-source Voltage (V <sub>GS</sub> = 0)	20	V
V <sub>DGR</sub>	Drain-gate Voltage (R <sub>GS</sub> = 20 kW)	20	V
V <sub>GS</sub>	Gate- source Voltage	$\pm$ 12	V
I <sub>D</sub>	Drain Current (continuous) at T <sub>C</sub> = 25°C	2.5	A
I <sub>D</sub>	Drain Current (continuous) at T <sub>C</sub> = 100°C	1.58	A
I <sub>DM</sub> (•)	Drain Current (pulsed)	10	A
P <sub>tot</sub>	Total Dissipation at T <sub>C</sub> = 25°C	2	W

### SCHOTTKY ABSOLUTE MAXIMUM RATINGS

Symbol	Parameter		Value	Unit
V <sub>RRM</sub>	Repetitive Peak Reverse Voltage		30	V
I <sub>F(RMS)</sub>	RMS Forward Curren		20	A
I <sub>F(AV)</sub>	Average Forward Current	T <sub>L</sub> =125 °C $\delta$ =0.5	3	A
I <sub>FSM</sub>	Surge Non Repetitive Forward Current	tp= 10 ms Sinusoidal	75	A
I <sub>RSM</sub>	Non Repetitive Peak Reverse Current	tp=100 $\mu$ s	1	A
dv/dt	Critical Rate Of Rise Of Reverse Voltage		10000	V/ $\mu$ s

(•) Pulse width limited by safe operating area

Note: For the P-CHANNEL MOSFET actual polarity of voltages and current has to be reversed

# STS2DPFS20V

## TERMAL DATA

Rthj-amb	(*)Thermal Resistance Junction-ambient MOSFET	62.5	°C/W
Rthj-amb	(*)Thermal Resistance Junction-ambient SCHOTTKY MAX	100	°C/W
T <sub>stg</sub>	Storage Temperature Range	-55 to 150	°C
T <sub>j</sub>	Maximum Lead Temperature For Soldering Purpose	150	°C

(\*) When Mounted on 1 inch<sup>2</sup> FR-4 board, 2 oz of Cu and t ≤ 10 sec

## ELECTRICAL CHARACTERISTICS (T<sub>case</sub> = 25 °C unless otherwise specified)

### OFF

Symbol	Parameter	Test Conditions	Min.	Typ.	Max.	Unit
V <sub>(BR)DSS</sub>	Drain-source Breakdown Voltage	I <sub>D</sub> = 250 μA, V <sub>GS</sub> = 0	20			V
I <sub>DSS</sub>	Zero Gate Voltage Drain Current (V <sub>GS</sub> = 0)	V <sub>DS</sub> = Max Rating V <sub>DS</sub> = Max Rating T <sub>C</sub> = 125°C			1 10	μA μA
I <sub>GSS</sub>	Gate-body Leakage Current (V <sub>DS</sub> = 0)	V <sub>GS</sub> = ± 12 V			±100	nA

### ON (1)

Symbol	Parameter	Test Conditions	Min.	Typ.	Max.	Unit
V <sub>GS(th)</sub>	Gate Threshold Voltage	V <sub>DS</sub> = V <sub>GS</sub> I <sub>D</sub> = 250 μA	0.6			V
R <sub>DS(on)</sub>	Static Drain-source On Resistance	V <sub>GS</sub> = 4.5 V I <sub>D</sub> = 1 A V <sub>GS</sub> = 2.7 V I <sub>D</sub> = 1 A		0.14 0.20	0.20 0.25	Ω Ω

## SCHOTTKY STATIC ELECTRICAL CHARACTERISTICS

Symbol	Parameter	Test Conditions	Min.	Typ.	Max.	Unit
I <sub>R</sub> (*)	Reversed Leakage Current	T <sub>J</sub> = 25 °C V <sub>R</sub> = 30 V T <sub>J</sub> = 125 °C V <sub>R</sub> = 30 V		30	0.2 100	mA mA
V <sub>F</sub> (*)	Forward Voltage drop	T <sub>J</sub> = 25 °C I <sub>F</sub> = 3 A T <sub>J</sub> = 125 °C I <sub>F</sub> = 3 A		0.40	0.51 0.46	mA mA

## DYNAMIC

Symbol	Parameter	Test Conditions	Min.	Typ.	Max.	Unit
g <sub>fs</sub> (*)	Forward Transconductance	V <sub>DS</sub> = 15 V I <sub>D</sub> = 1 A		4		S
C <sub>iss</sub>	Input Capacitance	V <sub>DS</sub> = 15V, f = 1 MHz, V <sub>GS</sub> = 0		315		pF
C <sub>oss</sub>	Output Capacitance			87		pF
C <sub>rss</sub>	Reverse Transfer Capacitance			17		pF

**ELECTRICAL CHARACTERISTICS** (continued)

**SWITCHING ON**

Symbol	Parameter	Test Conditions	Min.	Typ.	Max.	Unit
$t_{d(on)}$ $t_r$	Turn-on Delay Time Rise Time	$V_{DD} = 10\text{ V}$ $I_D = 1\text{ A}$ $R_G = 4.7\ \Omega$ $V_{GS} = 4.5\text{ V}$ (Resistive Load, Figure 3)		38 30		ns ns
$Q_g$ $Q_{gs}$ $Q_{gd}$	Total Gate Charge Gate-Source Charge Gate-Drain Charge	$V_{DD} = 10\text{ V}$ $I_D = 2\text{ A}$ $V_{GS} = 4.5\text{ V}$		3.5 0.34 0.8	4.7	nC nC nC

**SWITCHING OFF**

Symbol	Parameter	Test Conditions	Min.	Typ.	Max.	Unit
$t_{d(off)}$ $t_f$	Turn-off Delay Time Fall Time	$V_{DD} = 10\text{ V}$ $I_D = 1\text{ A}$ $R_G = 4.7\ \Omega$ , $V_{GS} = 4.5\text{ V}$ (Resistive Load, Figure 3)		45 11		ns ns

**SOURCE DRAIN DIODE**

Symbol	Parameter	Test Conditions	Min.	Typ.	Max.	Unit
$I_{SD}$ $I_{SDM} (\bullet)$	Source-drain Current Source-drain Current (pulsed)				2 10	A A
$V_{SD} (*)$	Forward On Voltage	$I_{SD} = 2\text{ A}$ $V_{GS} = 0$			1.2	V
$t_{rr}$ $Q_{rr}$ $I_{RRM}$	Reverse Recovery Time Reverse Recovery Charge Reverse Recovery Current	$I_{SD} = 2\text{ A}$ $di/dt = 100\text{ A}/\mu\text{s}$ $V_{DD} = 10\text{ V}$ $T_j = 150^\circ\text{C}$ (see test circuit, Figure 5)		15 7.5 1		ns nC A

(\*) Pulsed: Pulse duration = 300  $\mu\text{s}$ , duty cycle 1.5 %.  
 (•) Pulse width limited by safe operating area.

Safe Operating Area

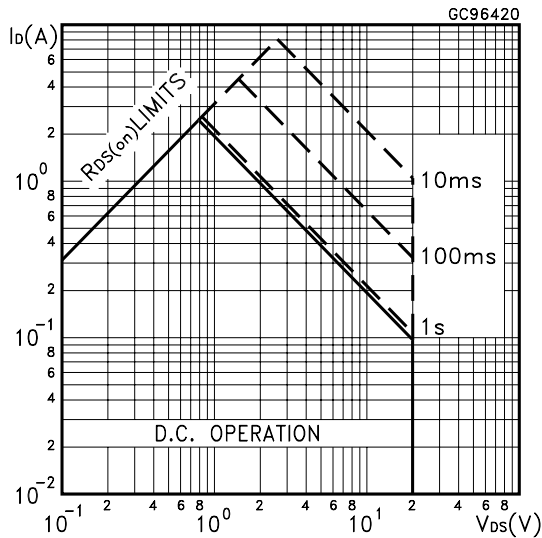

Thermal Impedance

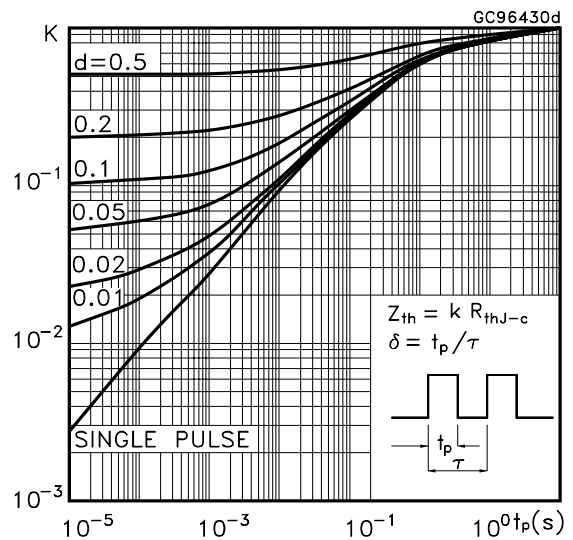

# STS2DPFS20V

Output Characteristics

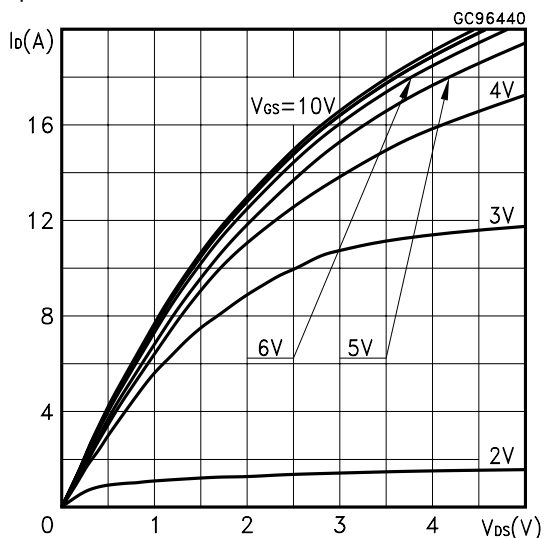

Transfer Characteristics

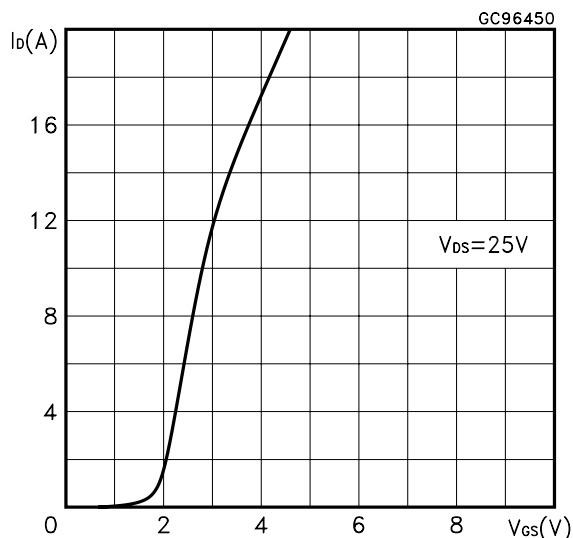

Transconductance

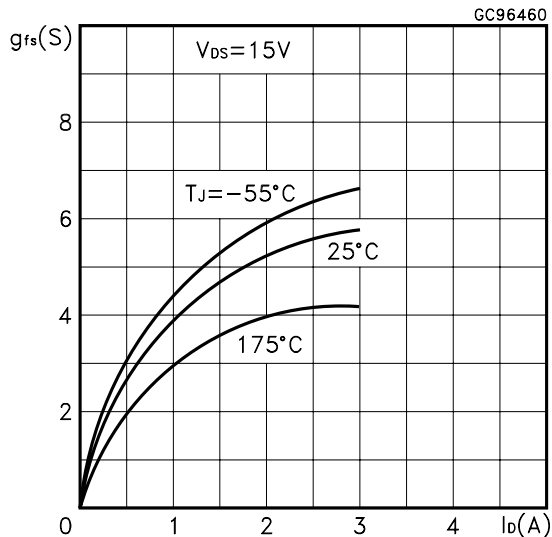

Static Drain-source On Resistance

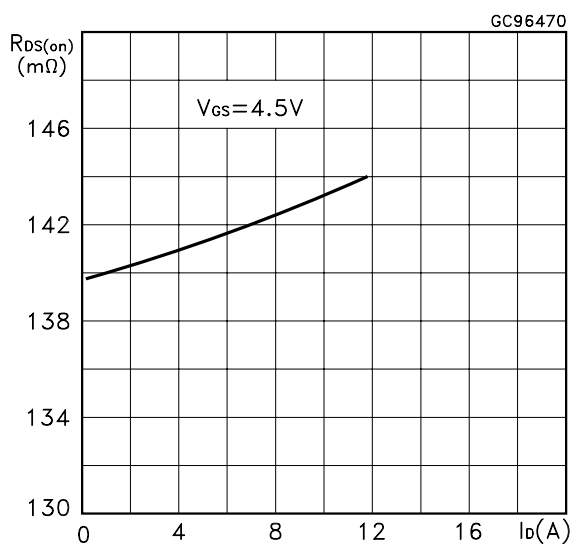

Gate Charge vs Gate-source Voltage

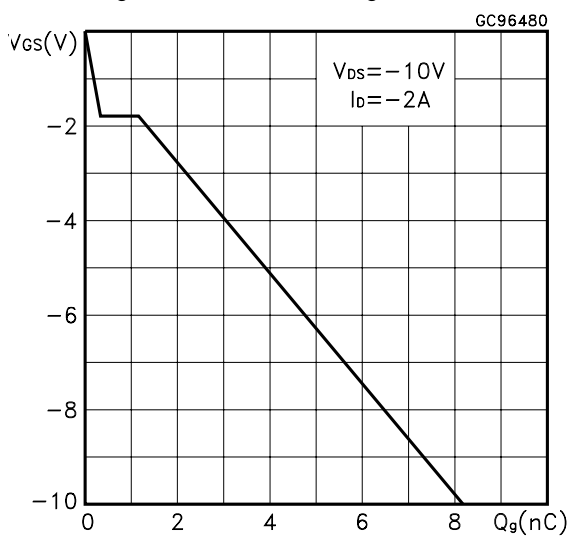

Capacitance Variations

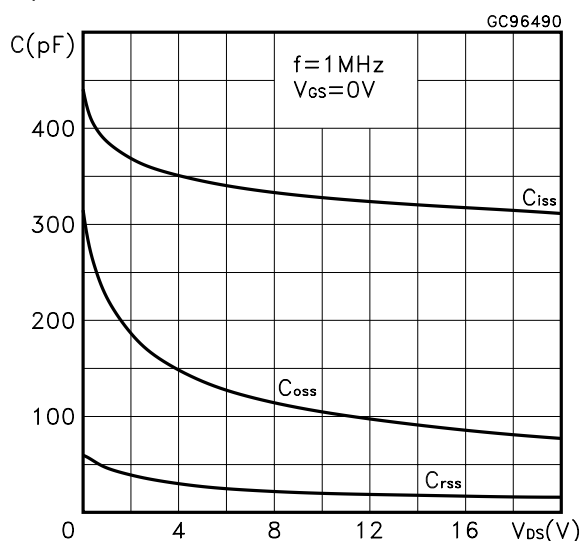

Normalized Gate Threshold Voltage vs Temperature

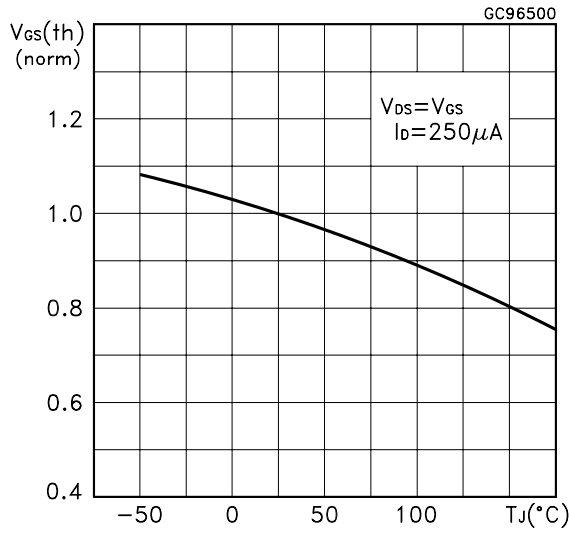

Normalized on Resistance vs Temperature

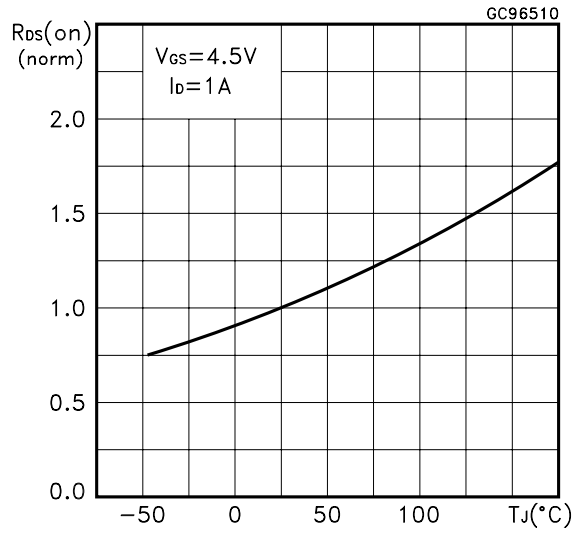

Source-drain Diode Forward Characteristics

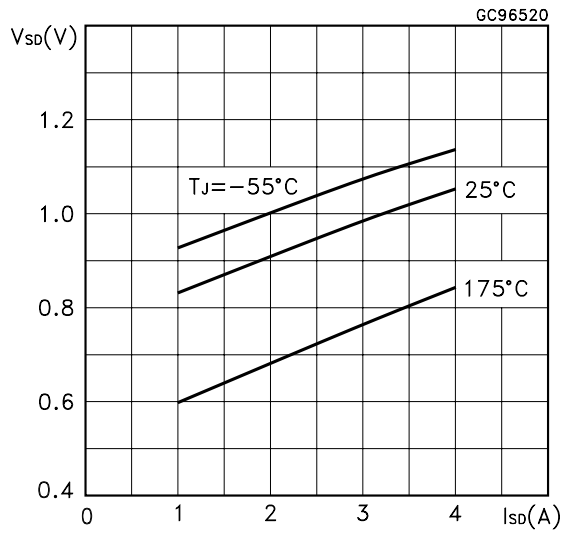

Normalized Breakdown Voltage vs Temperature.

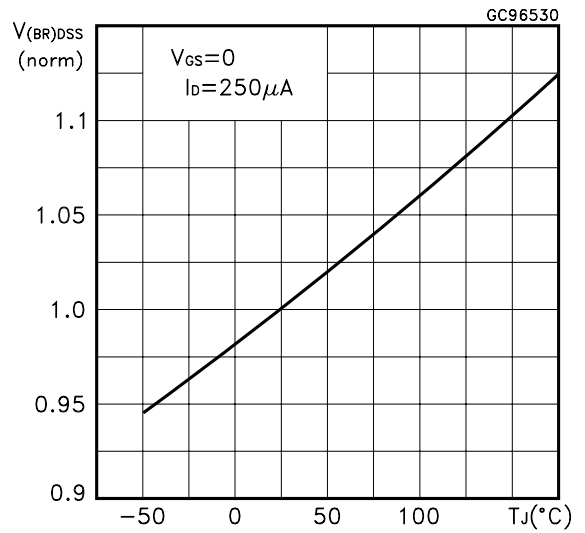

**Fig. 1: Unclamped Inductive Load Test Circuit**



**Fig. 2: Unclamped Inductive Waveform**



**Fig. 3: Switching Times Test Circuits For Resistive Load**



**Fig. 4: Gate Charge test Circuit**



**Fig. 5: Test Circuit For Inductive Load Switching And Diode Recovery Times**

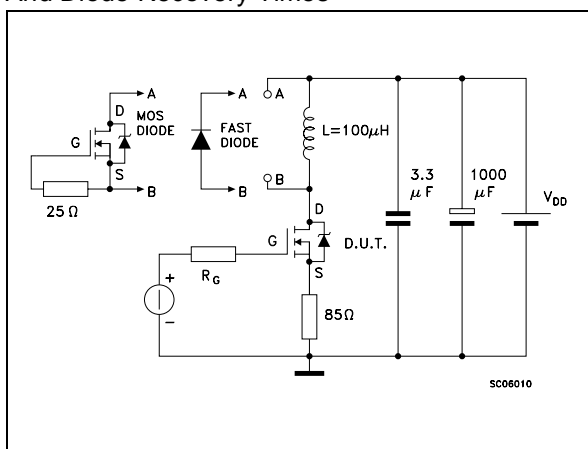

**SO-8 MECHANICAL DATA**

DIM.	mm			inch		
	MIN.	TYP.	MAX.	MIN.	TYP.	MAX.
A			1.75			0.068
a1	0.1		0.25	0.003		0.009
a2			1.65			0.064
a3	0.65		0.85	0.025		0.033
b	0.35		0.48	0.013		0.018
b1	0.19		0.25	0.007		0.010
C	0.25		0.5	0.010		0.019
c1	45 (typ.)					
D	4.8		5.0	0.188		0.196
E	5.8		6.2	0.228		0.244
e		1.27			0.050	
e3		3.81			0.150	
F	3.8		4.0	0.14		0.157
L	0.4		1.27	0.015		0.050
M			0.6			0.023
S	8 (max.)					



Information furnished is believed to be accurate and reliable. However, STMicroelectronics assumes no responsibility for the consequences of use of such information nor for any infringement of patents or other rights of third parties which may result from its use. No license is granted by implication or otherwise under any patent or patent rights of STMicroelectronics. Specifications mentioned in this publication are subject to change without notice. This publication supersedes and replaces all information previously supplied. STMicroelectronics products are not authorized for use as critical components in life support devices or systems without express written approval of STMicroelectronics.

The ST logo is registered trademark of STMicroelectronics  
© 2002 STMicroelectronics - All Rights Reserved

All other names are the property of their respective owners.

STMicroelectronics GROUP OF COMPANIES

Australia - Brazil - Canada - China - Finland - France - Germany - Hong Kong - India - Israel - Italy - Japan - Malaysia - Malta - Morocco -  
Singapore - Spain - Sweden - Switzerland - United Kingdom - United States.

<http://www.st.com>