

## NDS331N N-Channel Logic Level Enhancement Mode Field Effect Transistor

### General Description

These N-Channel logic level enhancement mode power field effect transistors are produced using Fairchild's proprietary, high cell density, DMOS technology. This very high density process is especially tailored to minimize on-state resistance. These devices are particularly suited for low voltage applications in notebook computers, portable phones, PCMCIA cards, and other battery powered circuits where fast switching, and low in-line power loss are needed in a very small outline surface mount package.

### Features

- 1.3 A, 20 V.  $R_{DS(ON)} = 0.21 \Omega$  @  $V_{GS} = 2.7$  V  
 $R_{DS(ON)} = 0.16 \Omega$  @  $V_{GS} = 4.5$  V.
- Industry standard outline SOT-23 surface mount package using proprietary SuperSOT™-3 design for superior thermal and electrical capabilities.
- High density cell design for extremely low  $R_{DS(ON)}$ .
- Exceptional on-resistance and maximum DC current capability.

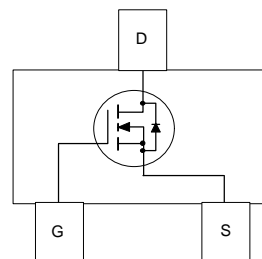
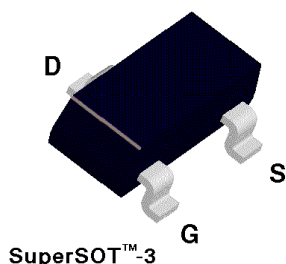

### Absolute Maximum Ratings $T_A = 25^\circ\text{C}$ unless otherwise noted

Symbol	Parameter	NDS331N	Units
$V_{DSS}$	Drain-Source Voltage	20	V
$V_{GSS}$	Gate-Source Voltage - Continuous	8	V
$I_D$	Maximum Drain Current - Continuous (Note 1a)	1.3	A
	- Pulsed	10	
$P_D$	Maximum Power Dissipation (Note 1a)	0.5	W
		(Note 1b)	
$T_J, T_{STG}$	Operating and Storage Temperature Range	-55 to 150	$^\circ\text{C}$

### THERMAL CHARACTERISTICS

$R_{\theta JA}$	Thermal Resistance, Junction-to-Ambient (Note 1a)	250	$^\circ\text{C}/\text{W}$
$R_{\theta JC}$	Thermal Resistance, Junction-to-Case (Note 1)	75	$^\circ\text{C}/\text{W}$

**ELECTRICAL CHARACTERISTICS** ( $T_A = 25^\circ\text{C}$  unless otherwise noted)

Symbol	Parameter	Conditions	Min	Typ	Max	Units
<b>OFF CHARACTERISTICS</b>						
$BV_{DSS}$	Drain-Source Breakdown Voltage	$V_{GS} = 0\text{ V}, I_D = 250\ \mu\text{A}$	20			V
$I_{DSS}$	Zero Gate Voltage Drain Current	$V_{DS} = 16\text{ V}, V_{GS} = 0\text{ V}$ $T_J = 125^\circ\text{C}$			1	$\mu\text{A}$
					10	$\mu\text{A}$
$I_{GSSF}$	Gate - Body Leakage, Forward	$V_{GS} = 8\text{ V}, V_{DS} = 0\text{ V}$			100	nA
$I_{GSSR}$	Gate - Body Leakage, Reverse	$V_{GS} = -8\text{ V}, V_{DS} = 0\text{ V}$			-100	nA
<b>ON CHARACTERISTICS</b> (Note 2)						
$V_{GS(th)}$	Gate Threshold Voltage	$V_{DS} = V_{GS}, I_D = 250\ \mu\text{A}$ $T_J = 125^\circ\text{C}$	0.5	0.7	1	V
			0.3	0.53	0.8	
$R_{DS(on)}$	Static Drain-Source On-Resistance	$V_{GS} = 2.7\text{ V}, I_D = 1.3\text{ A}$ $T_J = 125^\circ\text{C}$ $V_{GS} = 4.5\text{ V}, I_D = 1.5\text{ A}$		0.15	0.21	$\Omega$
				0.24	0.4	
				0.11	0.16	
$I_{D(on)}$	On-State Drain Current	$V_{GS} = 2.7\text{ V}, V_{DS} = 5\text{ V}$ $V_{GS} = 4.5\text{ V}, V_{DS} = 5\text{ V}$	3			A
			4			
$g_{FS}$	Forward Transconductance	$V_{DS} = 5\text{ V}, I_D = 1.3\text{ A}$		3.5		S
<b>DYNAMIC CHARACTERISTICS</b>						
$C_{iss}$	Input Capacitance	$V_{DS} = 10\text{ V}, V_{GS} = 0\text{ V},$ $f = 1.0\text{ MHz}$		162		pF
$C_{oss}$	Output Capacitance			85		pF
$C_{rss}$	Reverse Transfer Capacitance			28		pF
<b>SWITCHING CHARACTERISTICS</b> (Note 2)						
$t_{D(on)}$	Turn - On Delay Time	$V_{DD} = 5\text{ V}, I_D = 1\text{ A},$ $V_{GS} = 5\text{ V}, R_{Gen} = 6\ \Omega$		5	20	ns
$t_r$	Turn - On Rise Time			25	40	ns
$t_{D(off)}$	Turn - Off Delay Time			10	20	ns
$t_f$	Turn - Off Fall Time			5	20	ns
$Q_g$	Total Gate Charge	$V_{DS} = 5\text{ V}, I_D = 1.3\text{ A},$ $V_{GS} = 4.5\text{ V}$		3.5	5	nC
$Q_{gs}$	Gate-Source Charge			0.3		nC
$Q_{gd}$	Gate-Drain Charge			1		nC

**Electrical Characteristics** ( $T_A = 25^\circ\text{C}$  unless otherwise noted)

Symbol	Parameter	Conditions	Min	Typ	Max	Units
<b>DRAIN-SOURCE DIODE CHARACTERISTICS AND MAXIMUM RATINGS</b>						
$I_S$	Maximum Continuous Drain-Source Diode Forward Current				0.42	A
$I_{SM}$	Maximum Pulsed Drain-Source Diode Forward Current				10	A
$V_{SD}$	Drain-Source Diode Forward Voltage	$V_{GS} = 0\text{ V}$ , $I_S = 0.42\text{ A}$ (Note 2)		0.8	1.2	V

Notes:

- $R_{\theta JA}$  is the sum of the junction-to-case and case-to-ambient thermal resistance where the case thermal reference is defined as the solder mounting surface of the drain pins.  $R_{\theta JC}$  is guaranteed by design while  $R_{\theta CA}$  is determined by the user's board design.

$$P_D(t) = \frac{I_J - I_A}{R_{\theta J A(t)}} = \frac{I_J - I_A}{R_{\theta J C} + R_{\theta C A(t)}} = I_D^2(t) \times R_{DS(on)} \theta_{TJ}$$

Typical  $R_{\theta JA}$  using the board layouts shown below on 4.5"x5" FR-4 PCB in a still air environment:

- 250°C/W when mounted on a 0.02 in<sup>2</sup> pad of 2oz copper.
- 270°C/W when mounted on a 0.001 in<sup>2</sup> pad of 2oz copper.

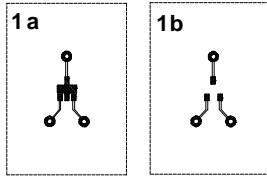

Scale 1 : 1 on letter size paper

- Pulse Test: Pulse Width  $\leq 300\mu\text{s}$ , Duty Cycle  $\leq 2.0\%$ .

## Typical Electrical Characteristics

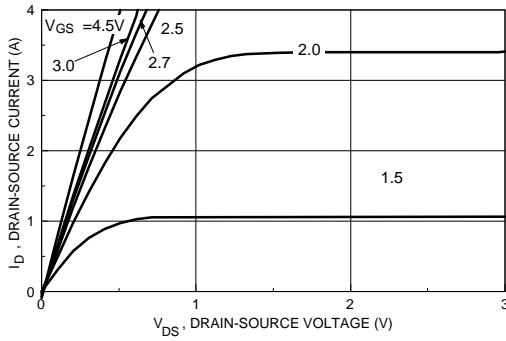

Figure 1. On-Region Characteristics.

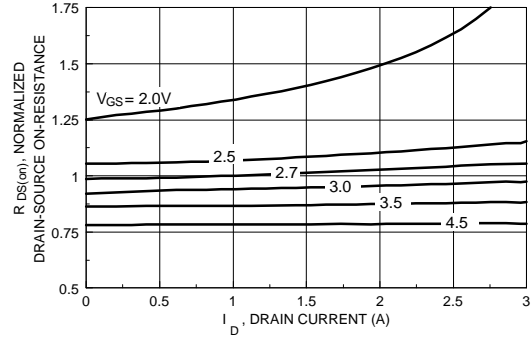

Figure 2. On-Resistance Variation with Drain Current and Gate Voltage.

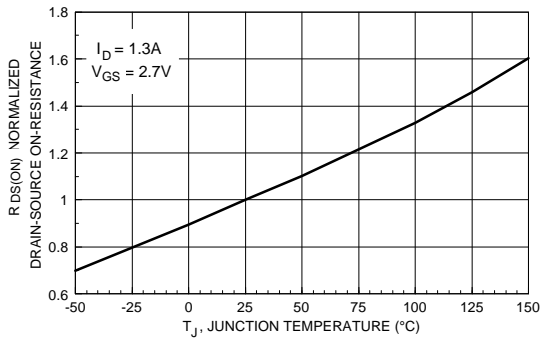

Figure 3. On-Resistance Variation with Temperature.

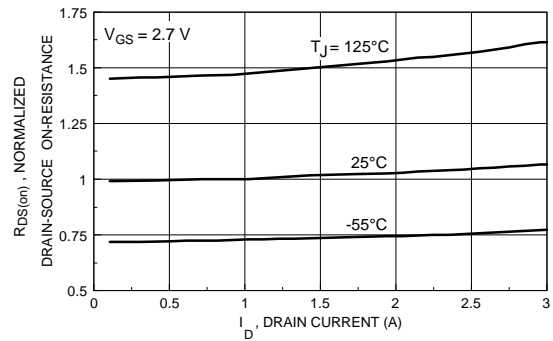

Figure 4. On-Resistance Variation with Drain Current and Temperature.

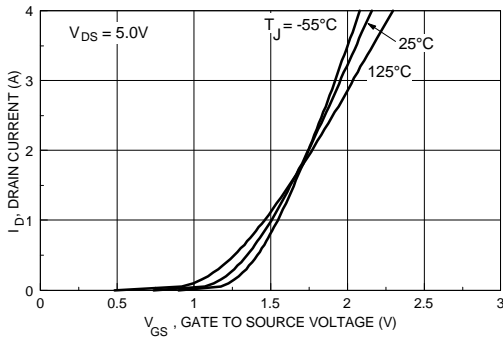

Figure 5. Transfer Characteristics.

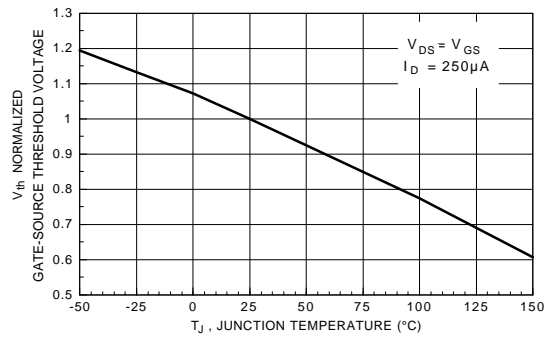

Figure 6. Gate Threshold Variation with Temperature.

## Typical Electrical Characteristics (continued)

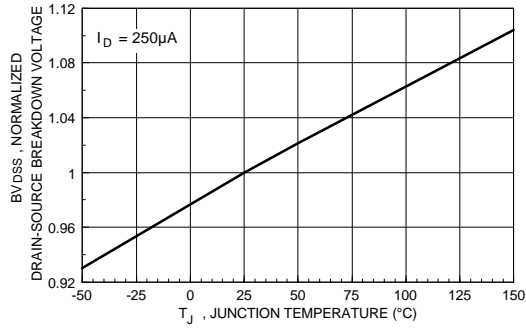

Figure 7. Breakdown Voltage Variation with Temperature.

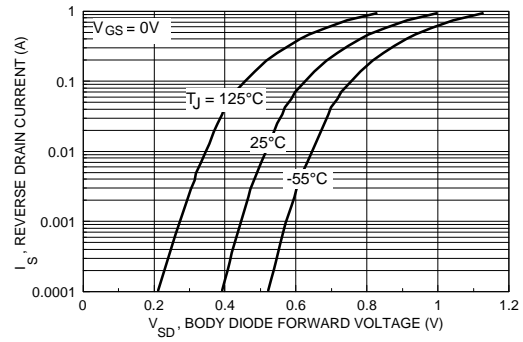

Figure 8. Body Diode Forward Voltage Variation with Source Current and Temperature.

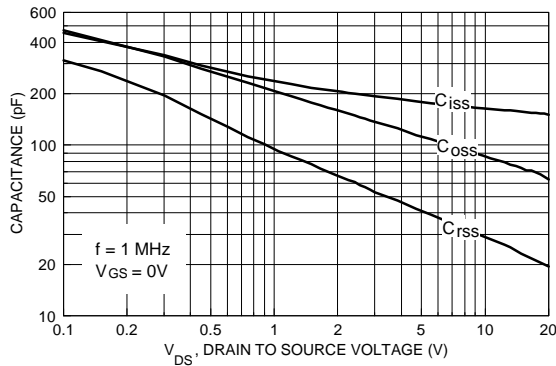

Figure 9. Capacitance Characteristics.

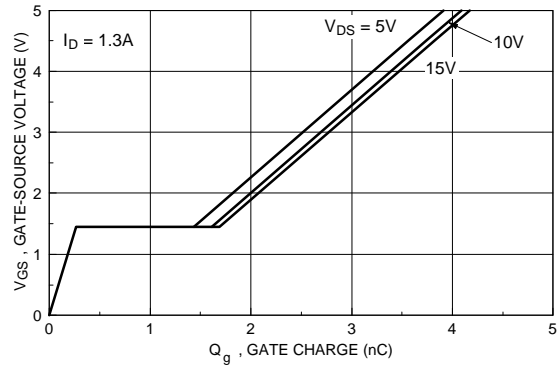

Figure 10. Gate Charge Characteristics.

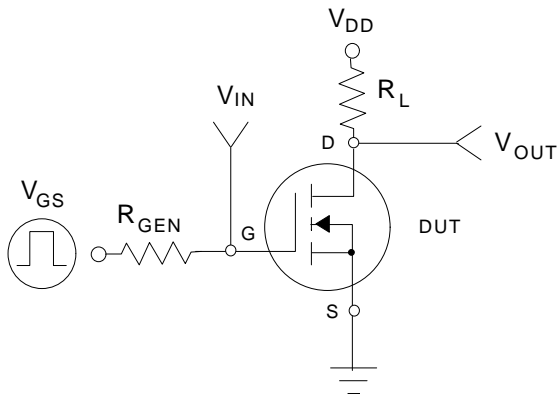

Figure 11. Switching Test Circuit.

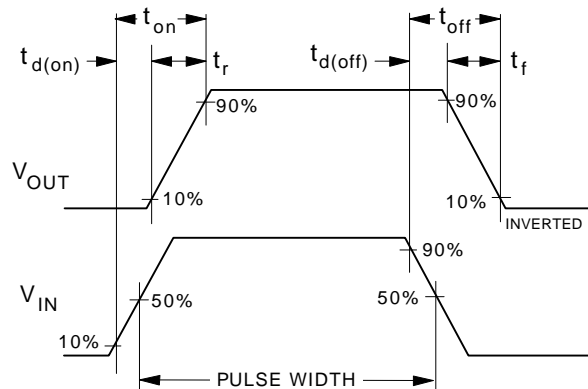
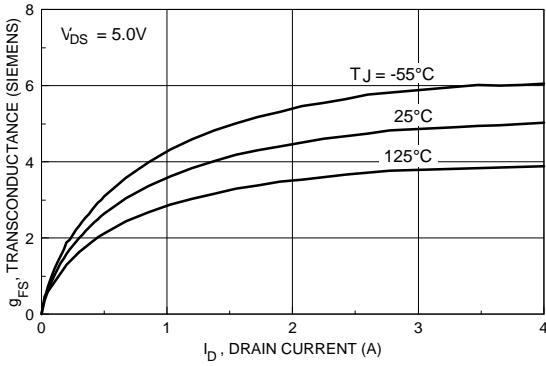
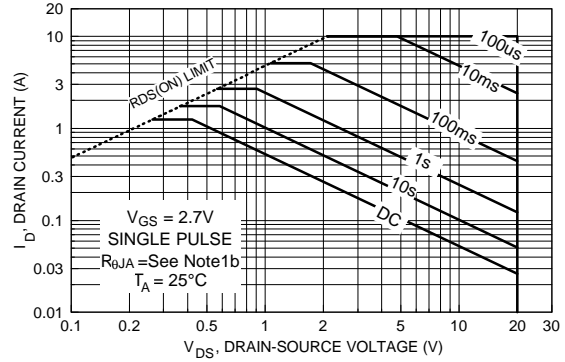

Figure 12. Switching Waveforms.

### Typical Electrical Characteristics (continued)



**Figure 13. Transconductance Variation with Drain Current and Temperature.**



**Figure 14. Maximum Safe Operating Area.**

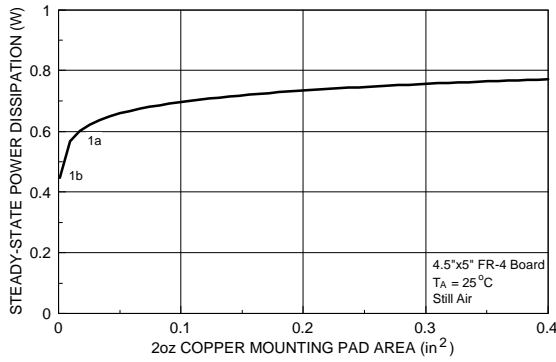

**Figure 15. SuperSOT™-3 Maximum Steady-State Power Dissipation versus Copper Mounting Pad Area.**

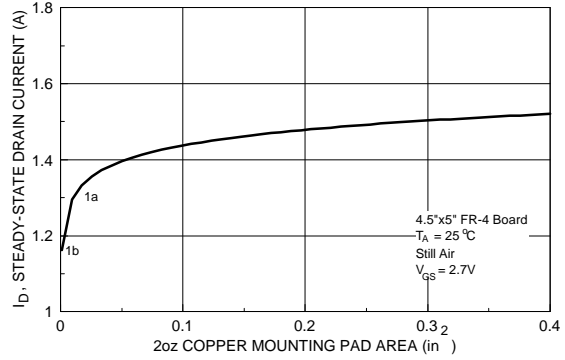

**Figure 16. Maximum Steady-State Drain Current versus Copper Mounting Pad Area.**

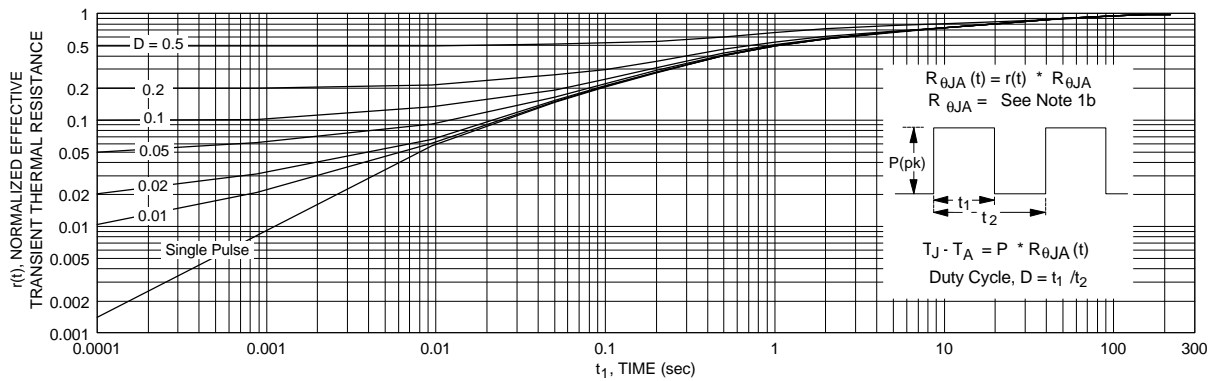

**Figure 17. Transient Thermal Response Curve.**

Note : Thermal characterization performed using the conditions described in note 1b. response will change depending on the circuit board design.

Transient thermal