

## HIGH VOLTAGE NPN POWER TRANSISTOR

- REVERSE PINS OUT Vs STANDARD IPAK/DPAK PACKAGE
- HIGH VOLTAGE CAPABILITY
- HIGH DC CURRENT GAIN
- THROUGH-HOLE IPAK (TO-251) POWER PACKAGE IN TUBE (SUFFIX "-1")
- SURFACE-MOUNTING DPAK (TO-252) POWER PACKAGE IN TAPE & REEL (SUFFIX "T4")

### APPLICATIONS:

- SWITCH MODE POWER SUPPLIES
- GENERAL PURPOSE SWITCHING

### DESCRIPTION

The BUXD87 is manufactured using High Voltage Multi Epitaxial Planar technology for high switching speeds and high voltage withstand capability.

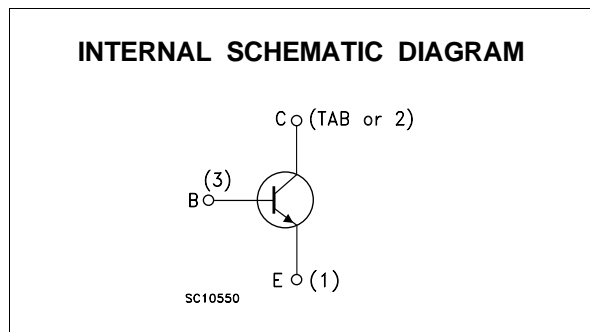
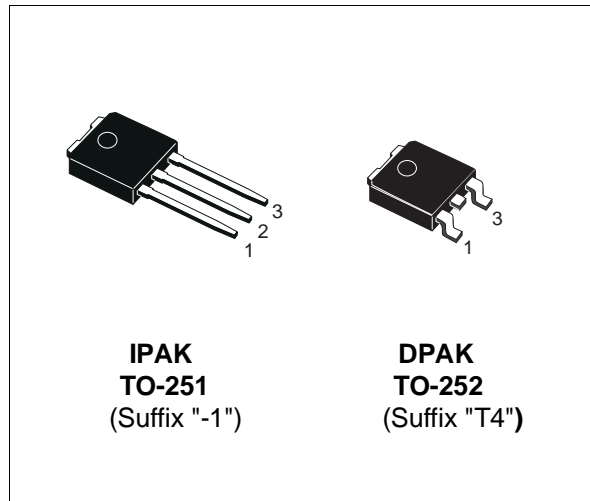

### ABSOLUTE MAXIMUM RATINGS

Symbol	Parameter	Value	Unit
$V_{CEV}$	Collector-Emitter Voltage ( $V_{BE} = -1.5V$ )	1000	V
$V_{CEO}$	Collector-Emitter Voltage ( $I_B = 0$ )	450	V
$V_{EBO}$	Emitter-Base Voltage ( $I_C = 0$ )	5	V
$I_C$	Collector Current	0.5	A
$I_{CM}$	Collector Peak Current ( $t_p < 5$ ms)	1	A
$I_B$	Base Current	0.3	A
$I_{BM}$	Base Peak Current ( $t_p < 5$ ms)	0.6	A
$P_{tot}$	Total Dissipation at $T_c = 25$ °C	20	W
$T_{stg}$	Storage Temperature	-65 to 150	°C
$T_j$	Max. Operating Junction Temperature	150	°C

# BUXD87

## THERMAL DATA

R <sub>thj-case</sub>	Thermal Resistance Junction-case	Max	6.25	°C/W
R <sub>thj-amb</sub>	Thermal Resistance Junction-ambient	Max	100	°C/W

## ELECTRICAL CHARACTERISTICS (T<sub>case</sub> = 25 °C unless otherwise specified)

Symbol	Parameter	Test Conditions	Min.	Typ.	Max.	Unit
I <sub>CEV</sub>	Collector Cut-off Current (V <sub>BE</sub> = -1.5V)	V <sub>CE</sub> = 1000 V V <sub>CE</sub> = 1000 V T <sub>j</sub> = 125 °C			100 1	μA mA
I <sub>EBO</sub>	Emitter Cut-off Current (I <sub>C</sub> = 0)	V <sub>EB</sub> = 5 V			1	mA
V <sub>CEO(sus)</sub>	Collector-Emitter Sustaining Voltage	I <sub>C</sub> = 100 mA	450			V
V <sub>BEO</sub>	Collector-Base Sustaining Voltage	I <sub>C</sub> = 10 mA	5			V
V <sub>CE(sat)*</sub>	Collector-Emitter Saturation Voltage	I <sub>C</sub> = 0.1 A I <sub>B</sub> = 0.01 A I <sub>C</sub> = 0.2 A I <sub>B</sub> = 0.02 A			0.8 1	V V
V <sub>BE(sat)*</sub>	Base-Emitter Saturation Voltage	I <sub>C</sub> = 0.2 A I <sub>B</sub> = 0.02 A			1	V
h <sub>FE*</sub>	DC Current Gain	I <sub>C</sub> = 50 mA V <sub>CE</sub> = 5 V I <sub>C</sub> = 40 mA V <sub>CE</sub> = 5 V	12	50		
f <sub>T</sub>	Transition Frequency	I <sub>C</sub> = 50 mA V <sub>CE</sub> = 10 V f=1MHz		20		MHz
t <sub>s</sub> t <sub>f</sub>	RESISTIVE LOAD Storage Time Fall Time	V <sub>CC</sub> = 250 V I <sub>C</sub> = 200 mA I <sub>B1</sub> = 40 mA I <sub>B2</sub> = -80 mA t <sub>p</sub> = 20 μs		4.5 0.5		μs μs

\* Pulsed: Pulse duration = 300 μs, duty cycle 1.5 %

## Safe Operating Area

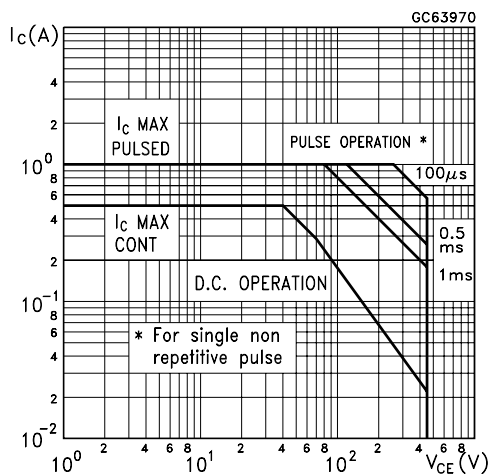

## Derating Curves

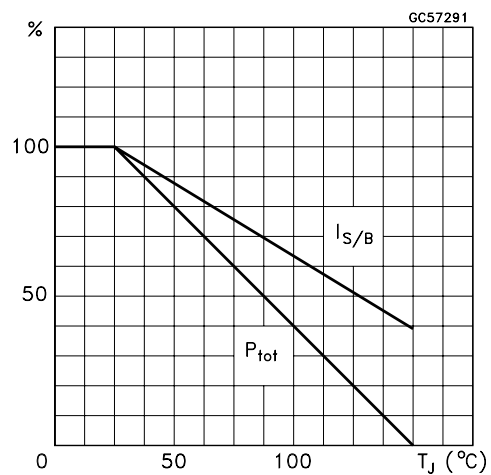

DC Current Gain

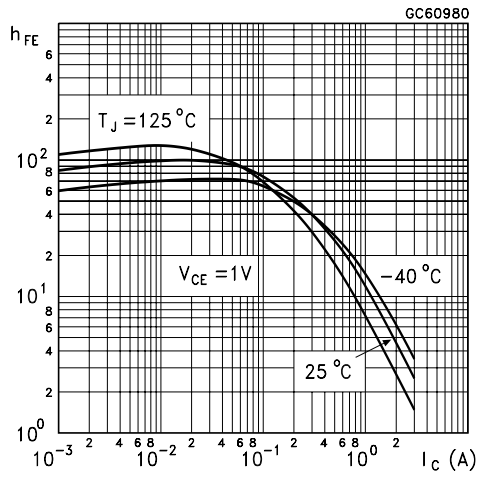

DC Current Gain

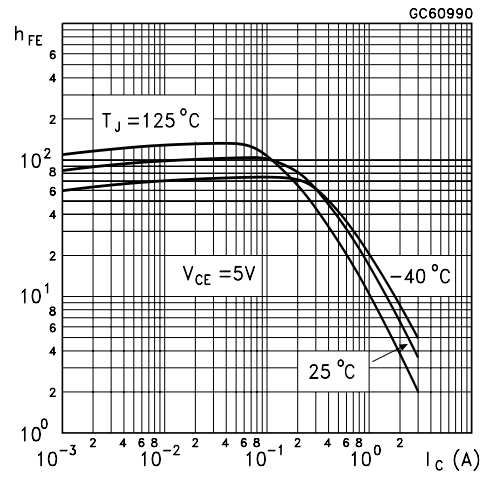

Collector Emitter Saturation Voltage

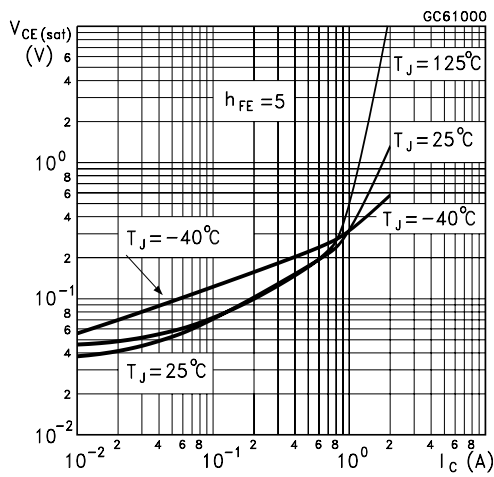

Base Emitter Saturation Voltage

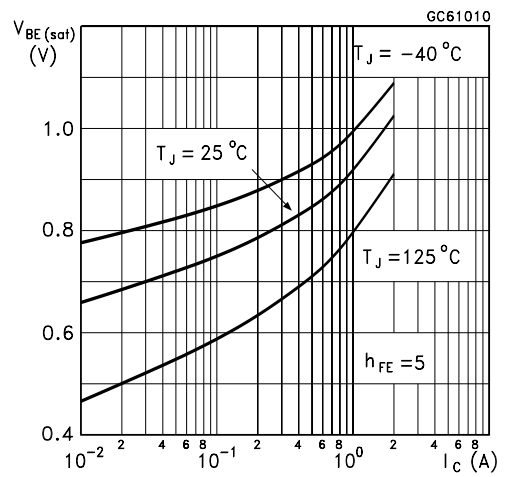

Reverse Biased SOA

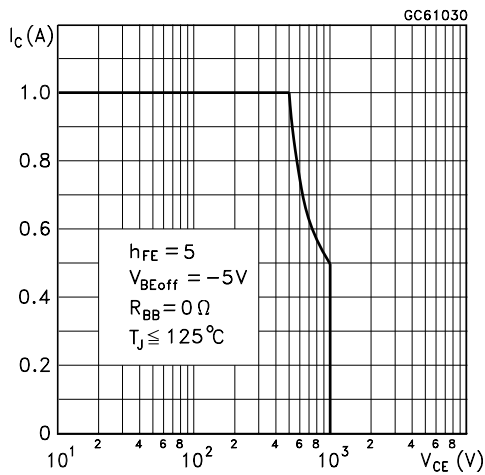

**TO-251 (IPAK) MECHANICAL DATA**

DIM.	mm			inch		
	MIN.	TYP.	MAX.	MIN.	TYP.	MAX.
A	2.20		2.40	0.087		0.094
A1	0.90		1.10	0.035		0.043
A3	0.70		1.30	0.028		0.051
B	0.64		0.90	0.025		0.035
B2	5.20		5.40	0.204		0.213
B3			0.85			0.033
B5		0.30			0.012	
B6			0.95			0.037
C	0.45		0.60	0.018		0.024
C2	0.48		0.60	0.019		0.024
D	6.00		6.20	0.237		0.244
E	6.40		6.60	0.252		0.260
G	4.40		4.60	0.173		0.181
H	15.90		16.30	0.626		0.642
L	9.00		9.40	0.354		0.370
L1	0.80		1.20	0.031		0.047
L2		0.80	1.00		0.031	0.039
V1		10°			10°	

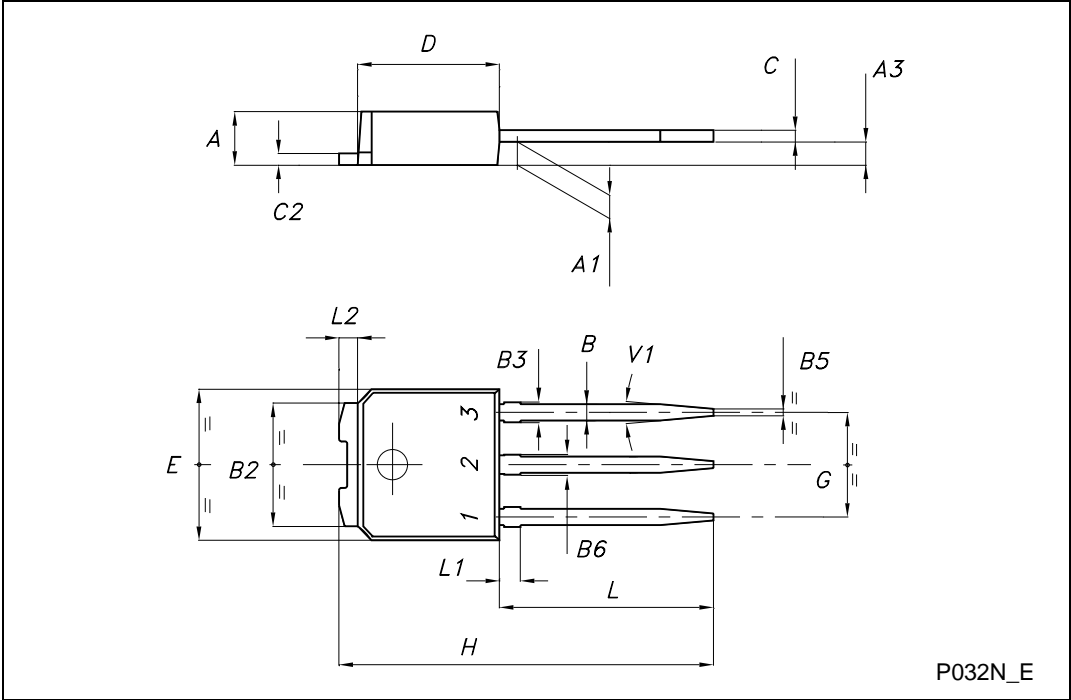

P032N\_E



**TO-252 (DPAK) MECHANICAL DATA**

DIM.	mm			inch		
	MIN.	TYP.	MAX.	MIN.	TYP.	MAX.
A	2.20		2.40	0.087		0.094
A1	0.90		1.10	0.035		0.043
A2	0.03		0.23	0.001		0.009
B	0.64		0.90	0.025		0.035
B2	5.20		5.40	0.204		0.213
C	0.45		0.60	0.018		0.024
C2	0.48		0.60	0.019		0.024
D	6.00		6.20	0.236		0.244
E	6.40		6.60	0.252		0.260
G	4.40		4.60	0.173		0.181
H	9.35		10.10	0.368		0.398
L2		0.8			0.031	
L4	0.60		1.00	0.024		0.039
V2	0°		8°	0°		0°

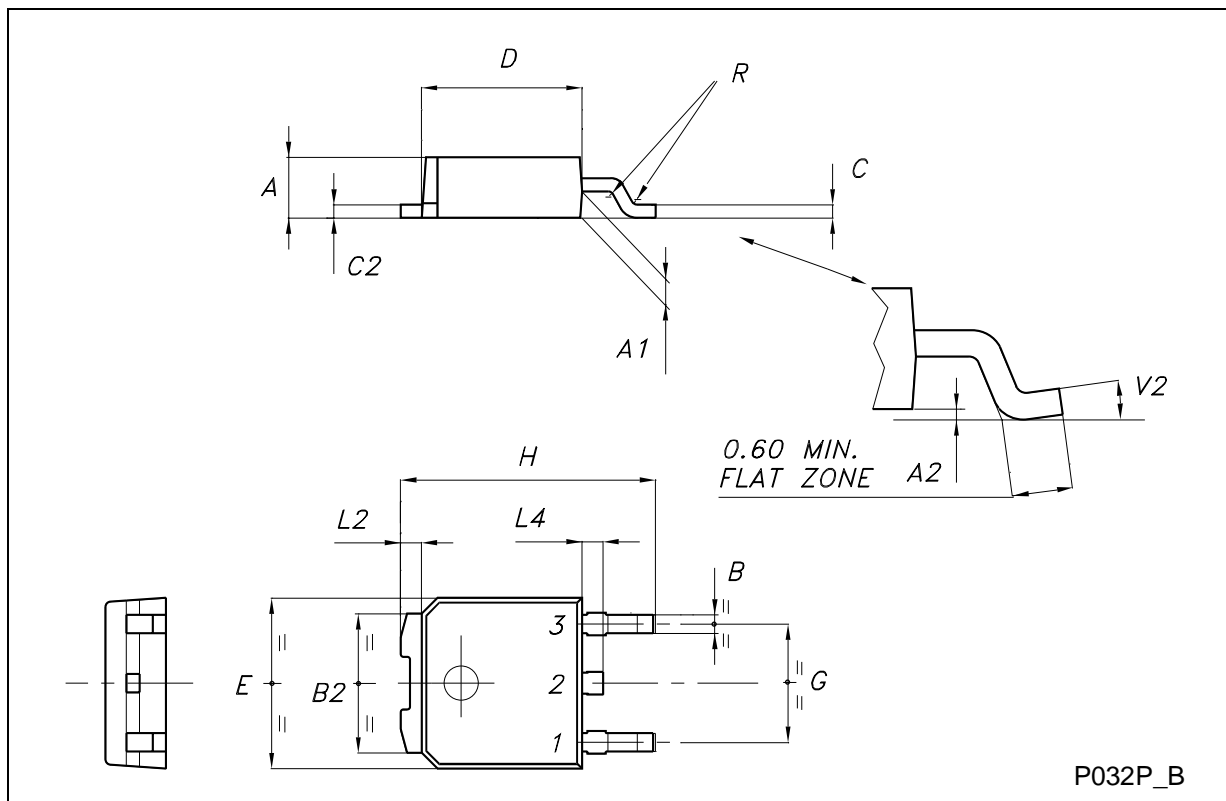

Information furnished is believed to be accurate and reliable. However, STMicroelectronics assumes no responsibility for the consequences of use of such information nor for any infringement of patents or other rights of third parties which may result from its use. No license is granted by implication or otherwise under any patent or patent rights of STMicroelectronics. Specification mentioned in this publication are subject to change without notice. This publication supersedes and replaces all information previously supplied. STMicroelectronics products are not authorized for use as critical components in life support devices or systems without express written approval of STMicroelectronics.

The ST logo is a trademark of STMicroelectronics

© 1999 STMicroelectronics – Printed in Italy – All Rights Reserved

STMicroelectronics GROUP OF COMPANIES

Australia - Brazil - Canada - China - France - Germany - Italy - Japan - Korea - Malaysia - Malta - Mexico - Morocco - The Netherlands - Singapore - Spain - Sweden - Switzerland - Taiwan - Thailand - United Kingdom - U.S.A.

<http://www.st.com>