

# TPS818

Luminosity Adjustment for TV Screens, CRT Monitors and Liquid-crystal Display Monitors  
 Notebook PCs and Portable Information Devices  
 Cellular and PHS Phones  
 Other Equipment Requiring Luminosity Adjustment

Unit: mm

The TPS818 is a linear-output (current output type) photo-IC which incorporates a photodiode and a current amp circuit in a single chip. A luminous efficiency correction filter mounted on the detector ensures accurate luminosity output levels. The device's excellent output linearity enables automatic adjustment of the luminosity of a TV screen or PC monitor in accordance with the ambient brightness of the operating environment.

- High sensitivity  
 : Light current  $I_L = 240 \mu\text{A}$  (typ.) @EV = 100 lx
- Little fluctuation in light current  
 : 1.67 times width ( $\pm 25^\circ$  typ.)
- Low current consumption  
 :  $I_{CC} = 1 \mu\text{A}$  (max) @VCC = 5.5 V
- Excellent illumination output linearity
- Luminous efficiency correction filter mounted on detector:  $\lambda_p = 560 \text{ nm}$  (typ.)
- Open-emitter output
- Side-view package
- Environmentally friendly silicon used as chip material instead of CdS  
 Suitable as a substitute for CdS-based products

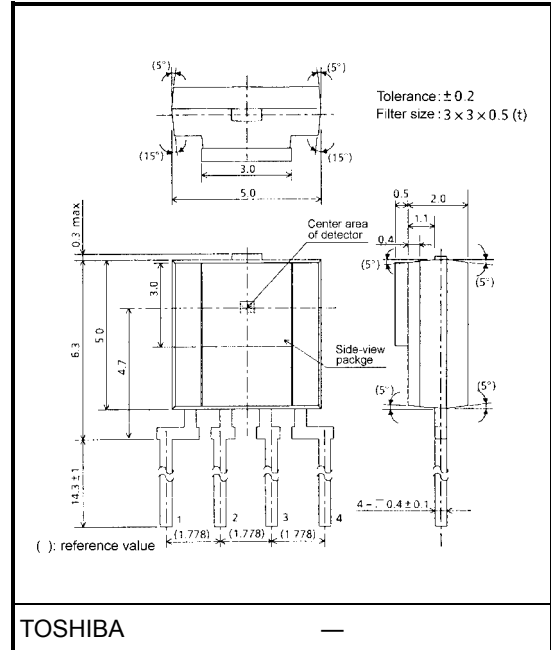

Weight: 0.22 g (typ.)

## Pin Connection

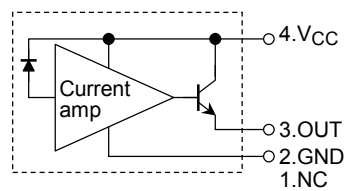

## Maximum Ratings (Ta = 25°C)

Characteristics	Symbol	Rating	Unit
Supply voltage	V <sub>CC</sub>	-0.5~7	V
Output voltage	V <sub>OUT</sub>	≤ V <sub>CC</sub>	V
Light current	I <sub>L</sub>	10	mA
Permissible power dissipation	P	150	mW
Operating temperature range	T <sub>opr</sub>	-25~85	°C
Storage temperature range	T <sub>stg</sub>	-40~100	°C
Soldering temperature range (5s) (Note 1)	T <sub>sol</sub>	260	°C

Note 1: Solder under the lead stopper.

## Electrical and Optical Characteristics (Ta = 25°C, V<sub>CC</sub> = 5 V)

Characteristics	Symbol	Test Condition	Min	Typ.	Max	Unit
Supply voltage	V <sub>CC</sub>	—	4.5	5	5.5	V
Supply current	I <sub>CC</sub>	V <sub>CC</sub> = 5.5 V, E <sub>V</sub> = 0	—	0.01	1	μA
Light current (1)	I <sub>L</sub> (1)	E <sub>V</sub> = 10 lx (Note 2)	18	24	30	μA
Light current (2)	I <sub>L</sub> (2)	E <sub>V</sub> = 100 lx (Note 2)	180	240	300	μA
Dark current	I <sub>LEAK</sub>	V <sub>CC</sub> = 5.5 V, E <sub>V</sub> = 0	—	—	0.5	μA
Peak sensitivity wavelength	λ <sub>P</sub>	—	—	560	—	nm
Switching time	t <sub>r</sub>	R <sub>L</sub> = 10 kΩ, λ = 570 nm	—	0.3	—	ms
	t <sub>f</sub>		—	0.8	—	

Note 2: A CIE Standard A light source is used (color temperature = 2870°K).

## Rise Time/Fall Time Measurement Method

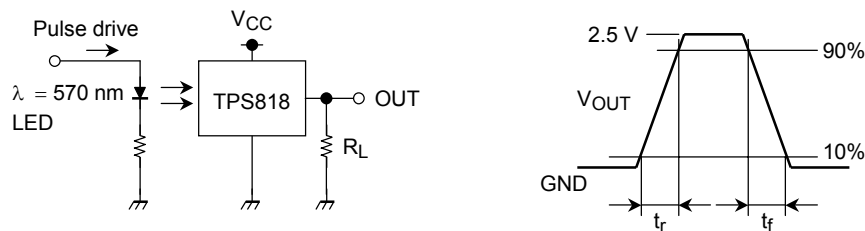

## Handling Precautions

- When forming the leads, bend each lead under the lead stopper. Soldering must be performed after the leads have been formed.
- Soldering must be performed under the stopper.
- To stabilize the power line, insert a bypass capacitor of up to 0.01 μF between V<sub>CC</sub> and GND, close to the device.

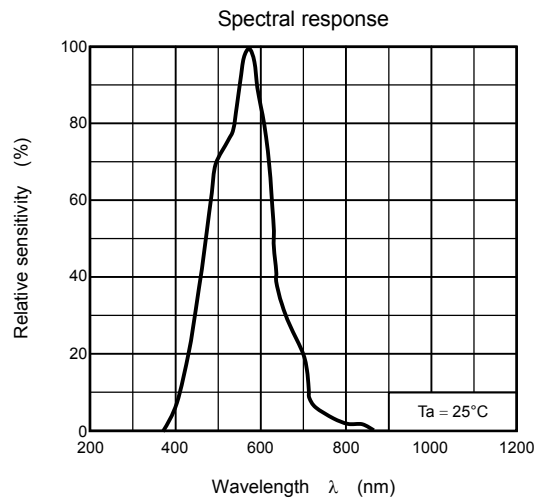
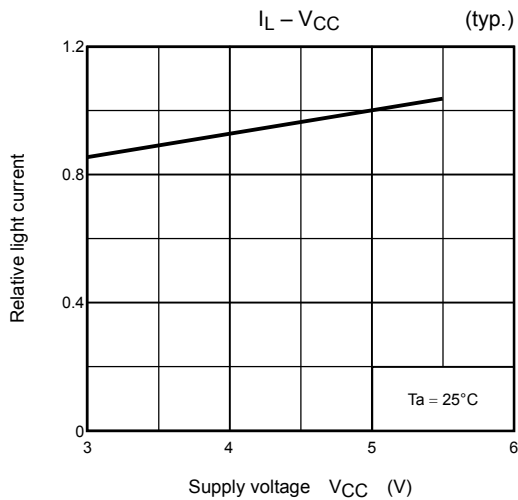
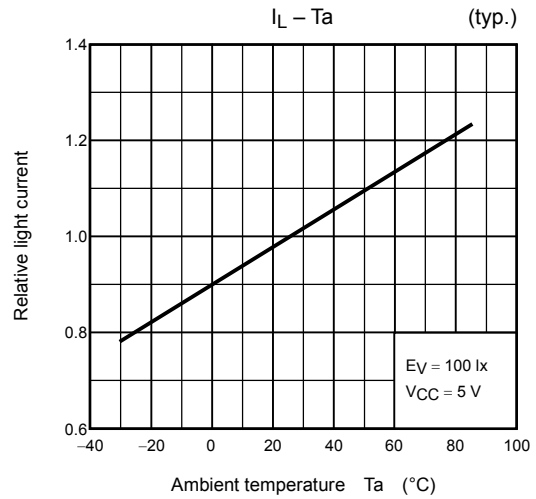
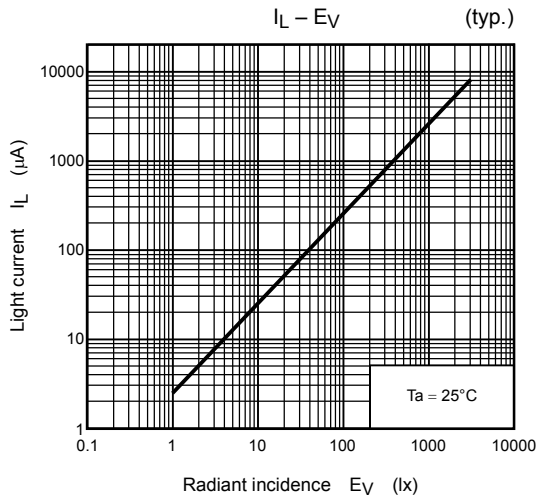
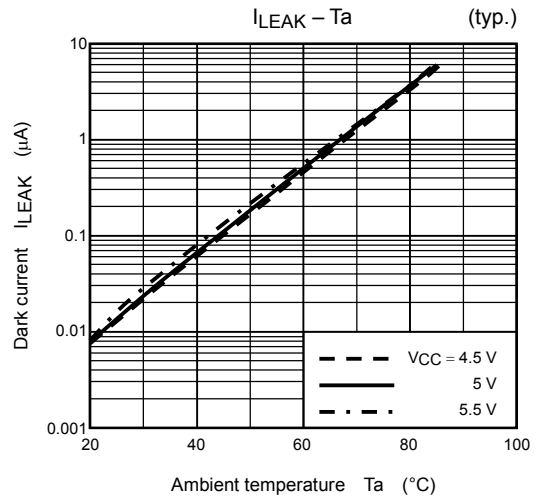
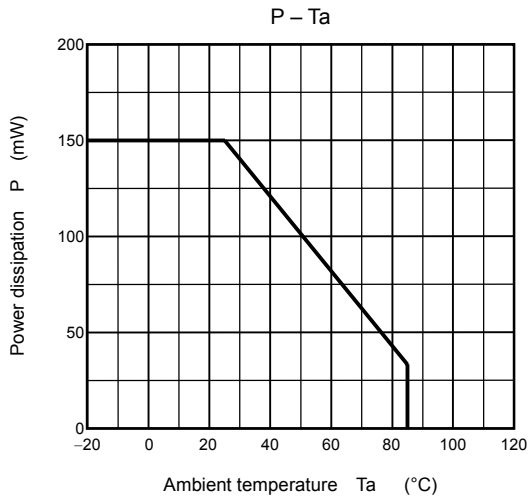

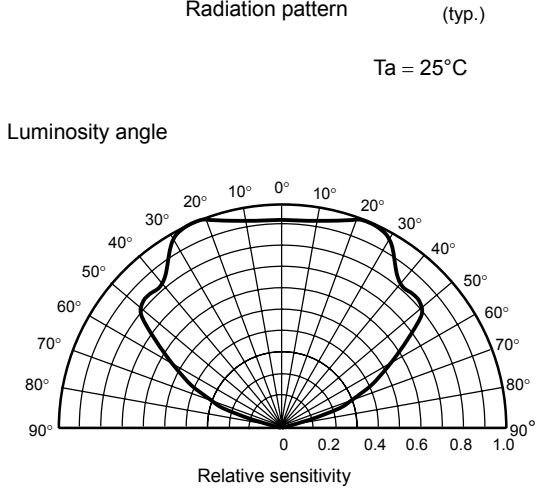
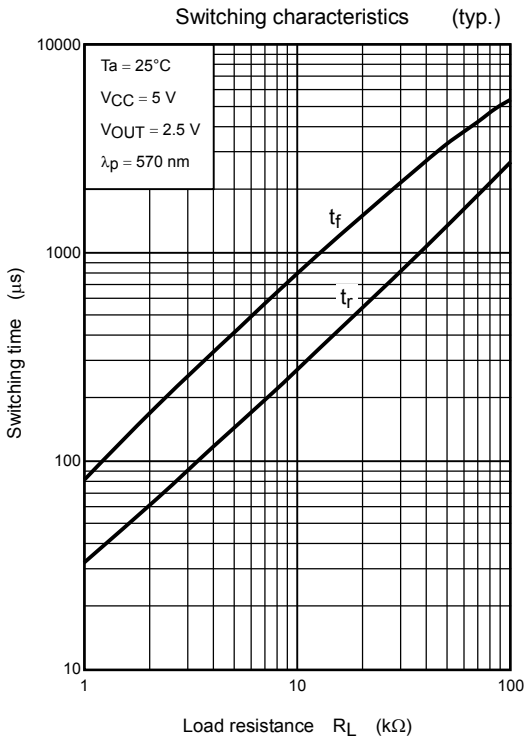

**RESTRICTIONS ON PRODUCT USE**

000707EBA

- TOSHIBA is continually working to improve the quality and reliability of its products. Nevertheless, semiconductor devices in general can malfunction or fail due to their inherent electrical sensitivity and vulnerability to physical stress. It is the responsibility of the buyer, when utilizing TOSHIBA products, to comply with the standards of safety in making a safe design for the entire system, and to avoid situations in which a malfunction or failure of such TOSHIBA products could cause loss of human life, bodily injury or damage to property.  
In developing your designs, please ensure that TOSHIBA products are used within specified operating ranges as set forth in the most recent TOSHIBA products specifications. Also, please keep in mind the precautions and conditions set forth in the "Handling Guide for Semiconductor Devices," or "TOSHIBA Semiconductor Reliability Handbook" etc..
- The TOSHIBA products listed in this document are intended for usage in general electronics applications (computer, personal equipment, office equipment, measuring equipment, industrial robotics, domestic appliances, etc.). These TOSHIBA products are neither intended nor warranted for usage in equipment that requires extraordinarily high quality and/or reliability or a malfunction or failure of which may cause loss of human life or bodily injury ("Unintended Usage"). Unintended Usage include atomic energy control instruments, airplane or spaceship instruments, transportation instruments, traffic signal instruments, combustion control instruments, medical instruments, all types of safety devices, etc.. Unintended Usage of TOSHIBA products listed in this document shall be made at the customer's own risk.
- The products described in this document are subject to the foreign exchange and foreign trade laws.
- The information contained herein is presented only as a guide for the applications of our products. No responsibility is assumed by TOSHIBA CORPORATION for any infringements of intellectual property or other rights of the third parties which may result from its use. No license is granted by implication or otherwise under any intellectual property or other rights of TOSHIBA CORPORATION or others.
- The information contained herein is subject to change without notice.