

3 INVERTER

The KIC7WU04FK is a high speed C²MOS INVERTER fabricated with silicon gate C²MOS technology. It achieves the high speed operation similar to equivalent LSTTL while maintaining the C²MOS low power dissipation. As the internal circuit is composed of single stage inverter, it can be applied for crystal oscillation. All inputs are equipped with protection circuits against static discharge or transient excess voltage.

FEATURES

- High Speed : $t_{pd}=6ns$ (Typ.) at $V_{CC}=5V$.
- Low Power Dissipation : $I_{CC}=1\mu A$ (Max.) at $T_a=25^\circ C$.
- High Noise Immunity : $V_{NIH}=V_{NIL}=10\% V_{CC}$ (Min.).
- Output Drive Capability : 10 LSTTL Loads.
- Symmetrical Output Impedance : $|I_{OH}|=I_{OL}=4mA$ (Min.)
- Balanced Propagation Delays : $t_{pLH} \approx t_{pHL}$
- Wide Operating Voltage Range : $V_{CC(opr)}=2\sim 6V$.

MAXIMUM RATINGS (Ta=25°C)

CHARACTERISTIC	SYMBOL	RATING	UNIT
Supply Voltage Range	V_{CC}	-0.5~7	V
DC Input Voltage	V_{IN}	-0.5~ $V_{CC}+0.5$	V
DC Output Voltage	V_{OUT}	-0.5~ $V_{CC}+0.5$	V
Input Diode Current	I_{IK}	± 20	mA
Output Diode Current	I_{OK}	± 20	mA
DC Output Current	I_{OUT}	± 25	mA
DC V_{CC} /Ground Current	I_{CC}	± 25	mA
Power Dissipation	P_D	200	mW
Storage Temperature	T_{stg}	-65~150	°C
Lead Temperature (10s)	T_L	260	°C

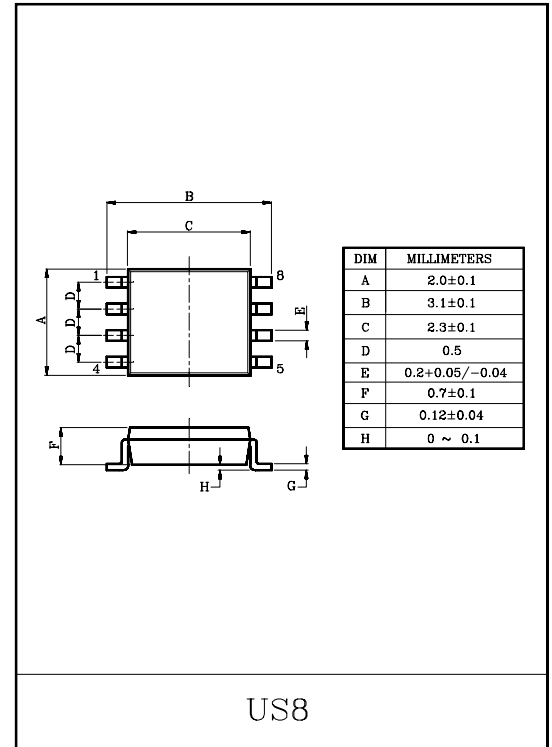

MARKING

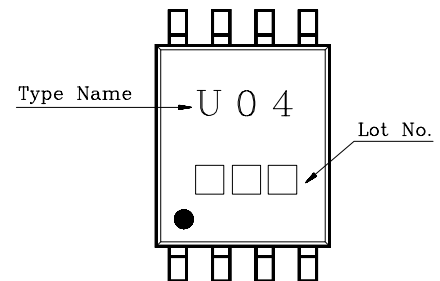

PIN CONNECTION(TOP VIEW)

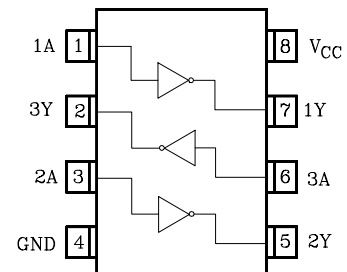

KIC7WU04FK

LOGIC DIAGRAM

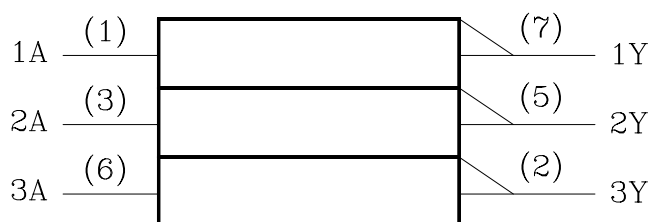

TRUTH TABLE

A	Y
L	H
H	L

RECOMMENDED OPERATING CONDITIONS

CHARACTERISTIC	SYMBOL	RATING	UNIT
Supply Voltage	V_{CC}	2~6	V
Input Voltage	V_{IN}	0~ V_{CC}	V
Output Voltage	V_{OUT}	0~ V_{CC}	V
Operating Temperature	T_{opr}	-40~85	°C

DC ELECTRICAL CHARACTERISTICS

CHARACTERISTIC	SYMBOL	TEST CONDITION	V_{CC}	$T_a=25^\circ\text{C}$			$T_a=-40\sim 85^\circ\text{C}$		UNIT	
				MIN.	TYP.	MAX.	MIN.	MAX.		
High-Level Input Voltage	V_{IH}	-	2.0	1.7	-	-	1.7	-	V	
			4.5	3.6	-	-	3.6	-		
			6.0	4.8	-	-	4.8	-		
Low-Level Input Voltage	V_{IL}	-	2.0	-	-	0.3	-	0.3	V	
			4.5	-	-	0.9	-	0.9		
			6.0	-	-	1.2	-	1.2		
High-Level Output Voltage	V_{OH}	$V_{IN}=V_{IL}$	$I_{OH}=-20\mu\text{A}$	2.0	1.8	2.0	-	1.8	-	V
				4.5	4.0	4.5	-	4.0	-	
		$V_{IN}=GND$	$I_{OH}=-4\text{mA}$ $I_{OH}=-5.2\text{mA}$	4.5	4.18	4.31	-	4.13	-	
				6.0	5.68	5.80	-	5.63	-	
Low-Level Output Voltage	V_{OL}	$V_{IN}=V_{IH}$	$I_{OL}=20\mu\text{A}$	2.0	-	0.0	0.2	-	0.2	V
				4.5	-	0.0	0.5	-	0.5	
		$V_{IN}=V_{CC}$	$I_{OL}=4\text{mA}$ $I_{OL}=5.2\text{mA}$	4.5	-	0.17	0.26	-	0.33	
				6.0	-	0.18	0.26	-	0.33	
Input Leakage Current	I_{IN}	$V_{IN}=V_{CC}$ or GND	6.0	-	-	± 0.1	-	± 1.0	μA	
Quiescent Supply Current	I_{CC}	$V_{IN}=V_{CC}$ or GND	6.0	-	-	1.0	-	10.0		

KIC7WU04FK

AC ELECTRICAL CHARACTERISTICS ($C_L=15\text{pF}$, $V_{CC}=5\text{V}$, $T_a=25^\circ\text{C}$)

CHARACTERISTIC	SYMBOL	TEST CONDITION	$T_a=25^\circ\text{C}$			UNIT
			MIN.	TYP.	MAX.	
Output Transition Time	t_{TLH} t_{THL}	-	-	4	8	ns
Propagation Delay Time	t_{pLH} t_{pHL}	-	-	4	8	ns

AC ELECTRICAL CHARACTERISTICS ($C_L=50\text{pF}$, Input $t_r=t_f=6\text{ns}$)

CHARACTERISTIC	SYMBOL	TEST CONDITION	V_{CC}	$T_a=25^\circ\text{C}$			$T_a=-40\sim 85^\circ\text{C}$		UNIT
				MIN.	TYP.	MAX.	MIN.	MAX.	
Output Transition Time	t_{TLH} t_{THL}	-	2.0	-	30	75	-	95	ns
			4.5	-	8	15	-	19	
			6.0	-	7	13	-	16	
Propagation Delay Time	t_{pLH} t_{pHL}	-	2.0	-	18	60	-	75	ns
			4.5	-	6	12	-	15	
			6.0	-	5	10	-	13	
Input Capacitance	C_{IN}	-	-	9	15	-	15	pF	
Power Dissipation Capacitance	C_{PD}	(Note 1)	-	13	-	-	-		

Note 1 : C_{PD} is defined as the value of internal equivalent capacitance of IC which is calculated from the operating current consumption without load (refer to Test Circuit.)

Average operating current can be obtained by the equation hereunder.

$$I_{CC(\text{opr})} = C_{PD} \cdot V_{CC} \cdot f_{IN} + I_{CC}/3 \text{ (per gate)}$$

SWITCHING CHARACTERISTICS TEST CIRCUIT

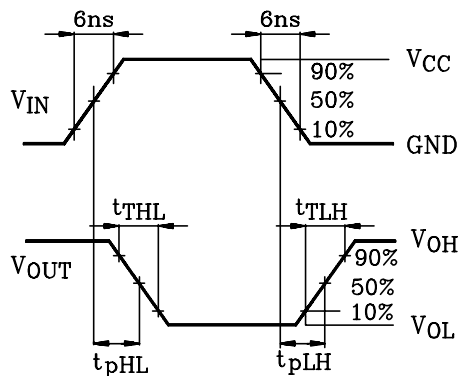
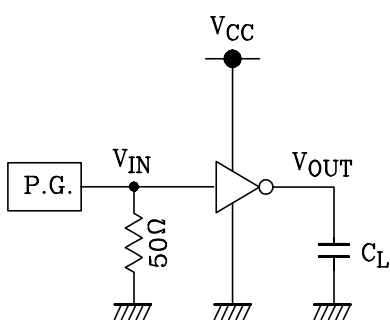

OPERATING CURRENT CONSUMPTION TEST CIRCUIT

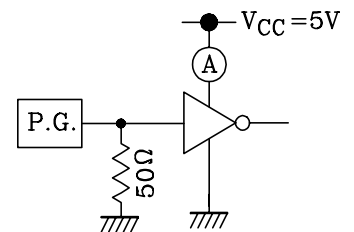

This input waveform is equal to SWITCHING CHARACTERISTICS TEST CIRCUIT input waveform.