

SONY®

CX20034/CXA1234AR

REC/PB Amplifier

Description

CX20034/CXA1234AR is a bipolar IC containing the periheral functions of a VTR head on a single chip. It has following functions.

- Recording
 - REC AMP (2 channels)
 - Gain controlled amplifier for each of the 4 REC signal inputs (Y, Chroma, PCM, AFT (Automatic Track Finding)).
 - Signal MIX, switch.
- Playback
 - Low noise head amplifier (2 channels).
 - Playback signal output switch.
- Control/Logic
 - Logic control circuits of each mode.

Features

- Single power supply 5V
- Low power consumption (about 80 mW in REC mode, 85 mW in PB mode) power saving mode.
- Audio PCM (after recording is possible) and ATF are provided.

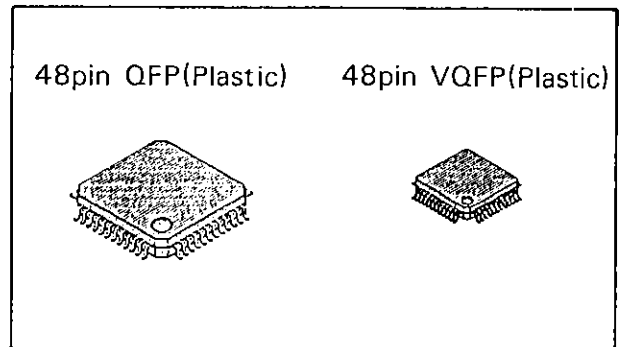

- DC REC signal (Y, Chroma, PCM and ATF) level control.
- Logic circuit is incorporated to control signal switching and save power in the REC, PB and after recording mode.

Structure

Bipolar silicon monolithic IC

Block Diagram

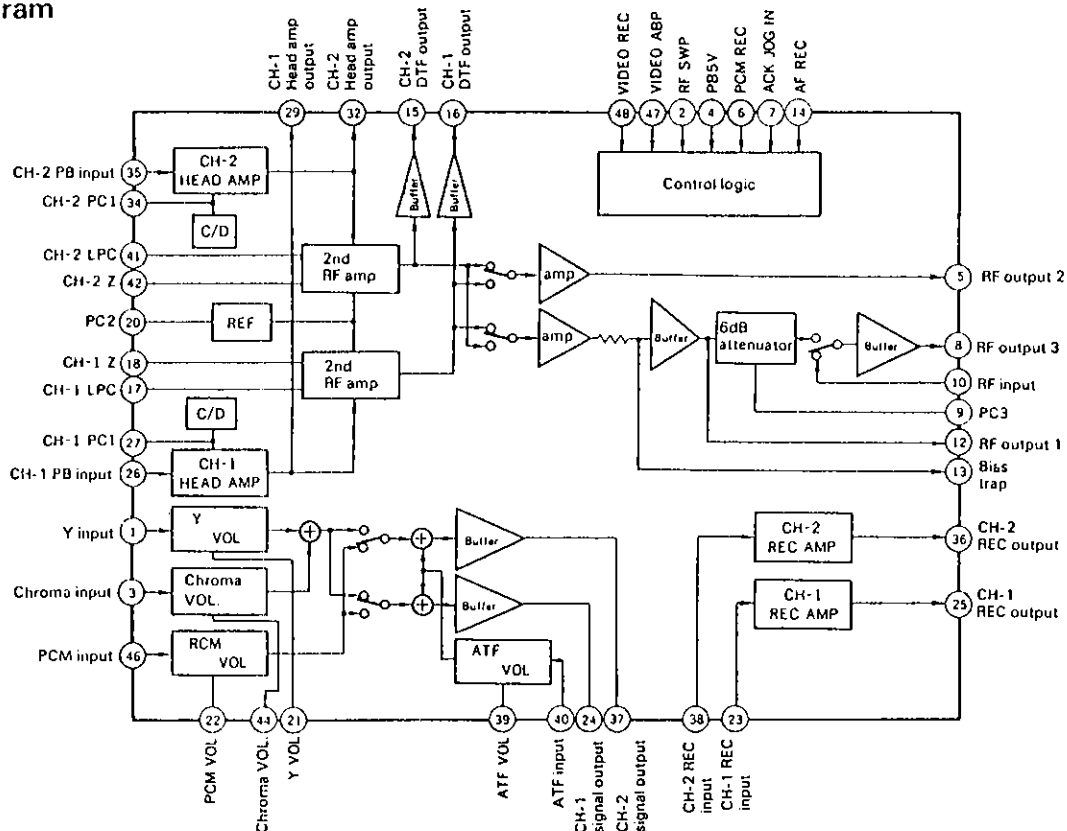

Absolute Maximum Ratings (Ta = 25°C)

• Supply voltage	Vcc	10	V
• Operating temperature	Topr	-20 to +75	°C
• Storage temperature	Tstg	-55 to +150	°C
• Allowable power dissipation	Pd (CX20034)	920	mW
	Pd (CXA1234AR)	1100	mW

(CXA1232AR; Substrate surface 40 × 25 mm, t=0.635 mm when ceramic substrate mounted.)

Recommended Operating Condition

• Supply voltage	Vcc	5.0 ± 0.25	V
------------------	-----	------------	---

Pin Description

E. F; Emitter Follower

No.	Name	Voltage (Typ.) (V)	Input/Output resistance (Typ.)	Operation/Description
1	Y input	3.3V in REC	20k Ω	Input pin for recording Y signal.
2	RF SWP	— (Open; L)	40k Ω	Input pin of RF switching pulse to switch CH. H: over 3V L: under 1V
3	Chroma input	2.3V in REC	20k Ω	Input pin for recording chroma signal.
4	PB 5V	— (Open; L)	40k Ω	Logic control pin switching PB ON or OFF. H: over 3V. L: under 1V.
5	RF output 2	3.4V in PB	(E.F)	Output pin for playback PCM signal.
6	PCM REC	— (Open; L)	40k Ω	Logic control pin to record PCM. Priority over VIDEO REC. H; over 3V, L; under 1V.
7	ACK JOG IN	— (Open; L)	3k Ω +PN junction	Switching between VIDEO signal (L) and RF signal (H) for RF output 3 in PB mode. H; over 25 μ A, L; under 5 μ A.
8	RF output 3	3.4V in PB	(E.F)	Playback output pin to be controlled by ACK JOG IN.
9	PC3	2.5V in PB		Attenuator bypass capacitor pin.
10	RF input	2.5V in PB	20k Ω	VIDEO signal input pin.
11	PB Vcc	5V	—	Power supply pin for PB and control logic.
12	RF output 1	2.5V in PB	(E.F)	Playback Video output pin.
13	Bias trap	3.3V in PB	500 Ω	Pin to connect a filter in the fixed head audio mode. Open when not in use.
14	AF REC	— (Open; L)	40k Ω	Logic control pin to set in after recording mode. H; over 3V, L; under 1V.
15	CH-2 DTF output	2.5V in PB	(E.F)	CH-2 signal output pin when DTF is in use. Open when not in use.
16	CH-1 DTF output	2.5V in PB	(E.F)	CH-1 signal output pin when DTF is in use. Open when not in use.
17	CH-1 LPC	1.7V in PB		Bypass capacitor pin for 2nd RF AMP.
18	CH-1Z	About 3.9V in PB		Connect a resonance circuit to Vcc. About 1.5k Ω of DC resistance from Vcc is desirable.
19	PB GND	—	—	GND for PB and control logic.
20	PC2	2.5V in PB		Bypass capacitor pin.

No.	Name	Voltage (Typ.) (V)	Input/Output resistance (Typ.)	Operation/Description
21	Y VOL	—	$\geq 100k\Omega$	Gain control DC voltage (2 to 3V) application pin for recording Y signal. Not open allowable.
22	PCM VOL	—	$\geq 100k\Omega$	Gain control DC voltage (2 to 3V) application pin for recording chroma signal. Not open allowable.
23	CH-1 REC input	0.7V in REC	$\approx 0\Omega$	Input pin for CH-1 REC AMP
24	CH-1 signal output	3.3V in REC	(E.F)	CH-1 signal output pin for recording VOL + SW.
25	CH-1 REC output	—	(Open collector)	CH-1 REC AMP output pin.
26	CH-1 PB input	2.3V in PB	1.7k Ω	CH-1 HEAD AMP input pin.
27	CH-1 PC1	1.7V in PB		Bypass capacitor pin for CH-1 HEAD AMP. (About 0.2 μ)
28	HEAD AMP Vcc	5V	—	Power supply pin for HEAD AMP.
29	CH-1 HEAD AMP output	3.1V in PB	(E.F)	CH-1 HEAD AMP output.
30	HEAD AMP GND	—	—	GND for HEAD AMP.
31	REC AMP GND	—	—	GND for REC AMP.
32	CH-2 HEAD AMP output	3.1V in PB	(E.F)	CH-2 HEAD AMP output pin
33	REC AMP Vcc	—	—	Power supply pin for REC AMP.
34	CH-2 PC1	1.7V in PB	—	Bypass capacitor pin for CH-2 HEAD AMP.
35	CH-2 PB input	2.3V in PB	1.7k Ω	Input pin for CH-2 HEAD AMP.
36	CH-2 REC output	—	(Open collector)	Output pin for CH-2 REC AMP.
37	CH-2 signal output	3.3V in REC	(E.F)	CH-2 signal output pin for recording VOL + SW.
38	CH-2 REC input	0.7V in REC	$\approx 0\Omega$	Input pin for CH-2 REC AMP.
39	ATF VOL		$\geq 100k\Omega$	Gain control DC voltage (2 to 3V) supply pin for recording ATF signal. Not open allowable.
40	ATF IN	2.3V in REC	20k Ω	Input pin for recording ATF signal.

No.	Name	Voltage (Typ.) (V)	Input/Output resistance (Typ.)	Operation/Description
41	CH-2 LPC	1.7V in PB	—	Bypass capacitor pin for 2nd RF AMP.
42	CH-2 Z	About 3.9V in PB	—	Connect a resonance circuit to Vcc. About 1.5k Ω DC resistance from Vcc is desirable.
43	REC GND	—	—	GND for REC except REC AMP.
44	Chroma VOL		$\geq 100k\Omega$	Gain control DC voltage (2 to 3V) supply pin for recording chroma signal. Not open allowable.
45	REC Vcc	5V		Power supply pin for REC except for REC AMP.
46	PCM input	3.3V in REC	20k Ω	Input pin for recording PCM signal.
47	VIDEO ABP	— (Open; L)	40k Ω	Logic mode control pin to record overlap by activating REC AMP for both channels. H; over 3V, L; under 1V.
48	VIDEO REC	— (Open; L)	40k Ω	Logic control pin to record VIDEO signal. H; over 3V, L; under 1V.

Control Logic Truth Table

Control logic input	(Input)						(Output)						Operation	Mode
	Control input condition						Operation of each section							
	AF REC Ⓐ	PB SV Ⓒ	VIDEO REC Ⓓ	PCM REC Ⓔ	RF SWP Ⓕ	VIDEO ABP Ⓖ	REC output			PB output				
Control logic condition						VOLUME-SW	CH-1 REC AMP	CH-2 REC AMP	HEAD AMP 2NDRF AMP RF output (VIDEO output)	RF output 2 (PCM output)				
SW 1	X	L	L	L	X	X	○	X	X	X	X	X	REC PAUSE	REC
SW 2	X	L	H	L	L	L	○	X	V	X	X	X	VIDEO REC	
SW 3	X	L	H	L	H	L	○	V	X	X	X	X	PCM REC	
SW 4	X	L	H	L	X	H	○	V	V	X	X	X		
SW 5	X	L	L	H	L	X	○	P	X	X	X	X	VIDEO PCM REC	
SW 6	X	L	L	H	H	X	○	X	P	X	X	X		
SW 7	X	L	H	H	L	X	○	P	V	X	X	X		
SW 8	X	L	H	H	H	X	○	V	P	X	X	X		
SW 9	L	H	L	L	L	X	X	X	X	○	CH ₋₂	CH ₋₁	PB	PB
SW 10	L	H	L	L	H	X	X	X	X	○	CH ₋₁	CH ₋₂		
SW 11	H	H	L	L	L	X	○	X	X	○	CH ₋₂	CH ₋₁	PB in dubbing	Dubbing
SW 12	H	H	L	L	H	X	○	X	X	○	CH ₋₁	CH ₋₂	PCM REC in dubbing	
SW 13	H	H	L	H	L	X	○	P	X	X	Z	Δ		
SW 14	H	H	L	H	H	X	○	X	P	X	Z	Δ		
SW9-SW12	ACKJOGIN Ⓣ ... H ACKJOGIN Ⓣ ... L						RFOUT3 outputs signal from FRIN in each mode of SW9-12. RFOUT3 outputs signal with the same channel for RFOUT1 in each mode of SW9-12.							

Description of input condition

- X Independent of H, L.
- H Control logic input, over 3V.
- L Control logic input, under 1V.
- Only for ACKJOGIN
- H Input current over 25μA.
- L Input current under 5μA.

Description of operation mode

- Operating
- X Not operating. Power saving.
- When VOLUME output is input to REC AMP (in REC mode)
- V VIDEO signal is output.
- P PCM signal is output.
- In PB mode
- CH-1 ... CH-1 signal is output.
- CH-2 ... CH-2 signal is output.
- Z DC level is held in place.
- Δ Current flows but no normal output is obtained.

* 1 See the Control Logic Truth Table for control logic conditions. * 2 See the Description of Circuit.
 Ta = 25°C, VCC = 5V

Electrical Characteristics

No.	Item	Symbol	Input condition * 2 input pin level · frequency	SW condition		Bias voltage				Output pin	Test content	Min.	Typ.	Max.	Unit
				* 1 Control logic condition	Other SW ON	V21 Y vol	V22 PCH vol	V44 Chroma vol	V39 ATF vol						
1	REC mode total current (in both CH REC)	I _{RECB}		SW4		2.6V	2.6V	2.6V	2.6V	I _{REC1} + I _{PB}	In both CH REC, sum of I _{REC1} and I _{PB} , internal consumption current. (Excluding REC output current)	13.5	17.0	21.5	mA
2	PB mode total current	I _{PB}		SW9		↓	↓	↓	↓	I _{REC1} + I _{PB}	In both CH PB, sum of I _{REC1} and I _{PB} , internal consumption current.	14.0	17.5	22.5	mA
3	REC output bias current (CH1) (CH2)	I _{OUT1}		SW3		↓	↓	↓	↓	I _{ROUT}	In each CH REC, REC output bias DC current (current flows through 82 Ω).	12.0	14.0	16.0	mA
		I _{OUT2}		SW2		↓	↓	↓	↓	↓	↓	In REC, assume CHARGE current PB → REC into the head amp bypass condenser (externally provided with CH-1 PC1, CH-2PC1). The current flow into the 3.5V power supply is measured.	-29.0	-22.0	-14.0
4	PC1 CHARGE current (CH1) (CH2)	I _{CC1}		SW5	Kc1	↓	↓	↓	↓	I _{CO}	In PB, assume DISCHARGE current REC → PB from the head amp bypass condenser (externally provided with CH-1 PC1, CH-2PC1). The current flow from the 3.5V power supply is measured.				
		I _{CC2}		SW6	Kc2	↓	↓	↓	↓	↓	↓				
5	PC1 DISCHARGE current (CH1) (CH2)	I _{DC1}		SW10	Kc1	↓	↓	↓	↓	↓					
		I _{DC2}		SW9	Kc2	↓	↓	↓	↓	↓	↓		28.0	34.0	40.0
6	RF output 1 DC voltage difference in switching inputs (CH-1, CH-2)	ΔV _{V12}		SW11 — SW12		↓	↓	↓	↓	12	DC voltage difference of RF output 1 in switching input modes (absolute value)			40	mA
7	RF output 2 DC voltage difference in switching PB output in place (Setting CH-1, CH-2)	ΔV _{VW}		SW11-SW13 — SW12-SW13		↓	↓	↓	↓	12	RF output 1 pin DC voltage. In normal PB output in DC setting mode.			90	mV
8	RF output 2 DC voltage difference in switching inputs (CH1 — CH2)	ΔV _{P12}		SW11 — SW12		↓	↓	↓	↓	5	DC voltage difference of RF output 2 in switching input modes (absolute value)			30	mV
< AC in REC system >															
9	Y VOL output level (MIN)	Y1MIN	1; -2dBm	1MHz	SW3	2.0V	2.6V	2.6V	2.6V	24	Output level in Y VOL GAIN MIN (Standard input level, 1 MHz)	-17.5	-16.3	-15.5	dBm
		Y2MIN	↓	↓	SW2	↓	↓	↓	↓	37					
10	Y VOL output level (TYP)	Y1TYP	↓	↓	SW3	2.6V	↓	↓	↓	24	Output level in Y VOL GAIN TYP (Standard input level, 1 MHz)	-11.5	-10.5	-9.5	dBm
		Y2TYP	↓	↓	SW2	↓	↓	↓	↓	37					

No.	Item	Symbol	Input condition *2 Input pin level · frequency	SW condition		Bias voltage				Output pin Ammeter name	Test content	Min.	Typ.	Max.	Unit
				*1 Control logic condition	Other SW ON	V21 Y vol	V22 PCH vol	V44 Chroma vol	V39 ATF vol						
11	Y VOL output level (MAX)	(CH1)	1; -2dBm 1MHz	SW3		3.0V	2.6V	2.6V	2.6V	24	Output level in Y VOL GAIN MAX (Standard input level, 1 MHz)	-4.5	-1.8	+1.0	dBm
		(CH2)		SW2						37					
12	Y VOL frequency response (TYP)	(CH1)	1; 1MHz	SW3		2.6V				24	Output level drops during 1 - 10 MHz in Y VOL GAIN TYP			1.0	dB
		(CH2)	1; 10MHz	SW2						37					
13	Y VOL 2nd harmonic (TYP)	(CH1)	1; 4MHz	SW3						24	2nd harmonic in Y VOL GAIN TYP (Standard input level, 4MHz)			-44	dB
		(CH2)	1; 4MHz	SW2						37					
14	PCM VOL output level (MIN)	(CH1)									Output level in PCM VOL GAIN MIN (Standard input level, 1MHz)	-17.5	-16.3	-15.5	dBm
		(CH2)	46; -2dBm 1MHz	SW6		2.0V				37					
15	PCM VOL output level (TYP)	(CH1)									Output level in PCM VOL GAIN TYP (Standard input level, 1MHz)	-11.5	-10.5	-9.5	dBm
		(CH2)	1; 1MHz	SW6		2.6V				37					
16	PCM VOL output level (MAX)	(CH1)									Output level in PCM VOL GAIN MAX (Standard input level, 1MHz)	-4.5	-1.8	+1.0	dBm
		(CH2)	1; 1MHz	SW6		3.0V				37					
17	PCM VOL frequency response (TYP)	(CH1)	1; 1MHz, 10MHz	SW5		2.6V				24	Output level drops during 1 to 10MHz in PCM VOL GAIN TYP			1.0	dB
		(CH2)	1; 1MHz, 10MHz	SW6						37					
18	PCM VOL 2nd harmonic (TYP)	(CH1)	1; 4MHz	SW5						24	2nd harmonic in PCM VOL GAIN TYP (Standard input level, 4MHz)			-42	dB
		(CH2)	1; 4MHz	SW6						37					
19	Chroma VOL output level (MIN)	(CH1)									Output level in chroma VOL GAIN MIN (Standard input level, 750kHz)	-29.7	-28.9	-28.2	dBm
		(CH2)	3; -12 dBm 750 kHz	SW2			2.0V			37					
20	Chroma VOL output level (TYP)	(CH1)	1; 1MHz	SW3						24	Output level in chroma VOL GAIN TYP (Standard input level, 750kHz)	-24.6	-23.8	-23.0	dBm
		(CH2)													
21	Chroma VOL output level (MAX)	(CH1)									Output level in chroma VOL GAIN MAX (Standard input level, 750kHz)	-19.0	-17.5	-15.8	dBm
		(CH2)	1; 1MHz	SW2			3.0V			37					
22	Chroma VOL 2nd harmonic (TYP)	(CH1)	1; 1MHz	SW3						24	2nd harmonic of chroma VOL GAIN TYP (Standard input level, 750kHz)			-44	dB
		(CH2)	1; 1MHz	SW2						37					
23	ATF VOL output level (MIN)	(CH1)	40; -2 dBm 100 kHz	SW3						24	Output level in ATF VOL GAIN MIN (Standard input level, 100kHz)	-44.0	-43.2	-42.0	dBm
		(CH2)	1; 1MHz	SW2						37					

No.	Item	Symbol	Input condition *2 Input pin level · frequency	SW condition		Bias voltage				Output pin Ammeter name	Test content	Min.	Typ.	Max.	Unit
				Control logic condition	Other SW ON	V21 Y vol	V22 PCH vol	V44 Chroma vol	V39 ATF vol						
24	ATF VOL output level (MIN)	A1MAX (CH1)	40; -2dBm 100kHz	SW3		2.6V	2.6V	2.6V	3.0V	24	Output level in ATF VOL GAIN MAX (Standard input level, 100kHz)	-31.0	-29.0	-27.0	dBm
		A2MAX (CH2)		SW2						37					
25	ATF VOL 2nd harmonic (MAX)	DA1 (CH1)		SW3						24	2nd harmonic in ATF VOL GAIN MAX. (Standard input level, 100kHz)			-40	dB
		DA2 (CH2)		SW2						37					
26	REC AMP output level	R1 (CH1)	23; -10 dBm 1MHz	SW3					2.6V	25	Output voltage level when REC AMP 82Ω is loaded (-10dBm, 1MHz input)	-16.5	-15.3	-14.0	dBm
		R2 (CH2)		SW2						36					
27	REC AMP frequency response	ΔR1 (CH1)	23; 1MHz 10MHz	SW3						25	Output level drops during 1 to 10MHz when REC AMP 82Ω is loaded.			2.0	dB
		ΔR2 (CH2)		SW3						36					
28	REC AMP	DR1 (CH1)	23; 4MHz	SW3						25	2nd harmonic when REC AMP 82Ω is loaded. (-10dBm input, 4MHz)		-48	-38	dB
		DR2 (CH2)		SW2						36					
29	REC AMP channel balance	ΔR12	23; 1MHz	SW3						25	Output voltage level difference between CH-1 and CH-2 when REC AMP 82Ω is loaded. (Absolute value) (-10dBm input, 4MHz)			0.7	dB
			38; 1MHz	SW2						36					
< AC in PB system >															
30	RF output 1 output level (CH2)	PB12	35; -69.5 dBm 1MHz	SW9		2.6V	2.6V	2.6V	2.6V	12	RF output 1 output level (-69.5 dBm input, 1MHz)	-8.5	-6.3	-4.5	dBm
31	RF output 2 output level (CH2)	PB21 (CH1)	26; 1MHz	SW9						5	RF output 2 output level (-69.5 dBm input, 1MHz)	-14.5	-12.0	-10.5	dBm
		PB22 (CH2)		SW10						5					

No.	Item	Symbol	Input condition *2 Input pin level · frequency	SW condition		Bias voltage				Output pin Ammeter name	Test content	Min.	Typ.	Max.	Unit
				*1 Control logic condition	Other SW ON	V21 Y vol	V22 PCH vol	V44 Chroma vol	V39 ATF vol						
32	RF output 2 frequency response (CH1) (CH2)	ΔPB21 ΔPB22	26; -69.5dBm 1MHz 35; ↓	SW9		2.6V	2.6V	2.6V	2.6V	5	Output level drops during 1 to 10MHz in RF output 2 output.			2.7	dB
				SW10		↓	↓	↓	↓	5					
33	RF output 3 output level (CH1) (CH2)	PB31 ΔPB32	26; ↓ 35; ↓	SW10 7pin-L		↓	↓	↓	↓	8	RF output 3 output level (-69.5dBm input, 1MHz)	-14.5	-12.0	-10.5	dBm
				SW9 7pin-L		↓	↓	↓	↓	8					
34	RF output 3 frequency response (CH1) (CH2)	ΔPB31 ΔPB32	26; ↓ 35; ↓	SW10 7pin-L		↓	↓	↓	↓	8	Output level drops during 1 to 10MHz in RF output 3 output.			3.2	dB
				SW9 7pin-L		↓	↓	↓	↓	8					
35	RF output 3 output level of RFIN input	PB3AJ	10; -12 dBm	SW10 7pin-H		↓	↓	↓	↓	8	1MHz output level in RFIN — RF output 3 modes.	-12.9	-12.1	-11.6	dBm
				SW9 7pin-L		↓	↓	↓	↓	8					
36	RF output 3 output frequency response of RFIN input	ΔPB3AJ	10; ↓ 1MHz, 10MHz	SW10 7pin-H		↓	↓	↓	↓	8	Output level drops during 1 to 10MHz in RFIN — RF output 3 modes.			22	dB

Electrical Characteristics Test Circuit

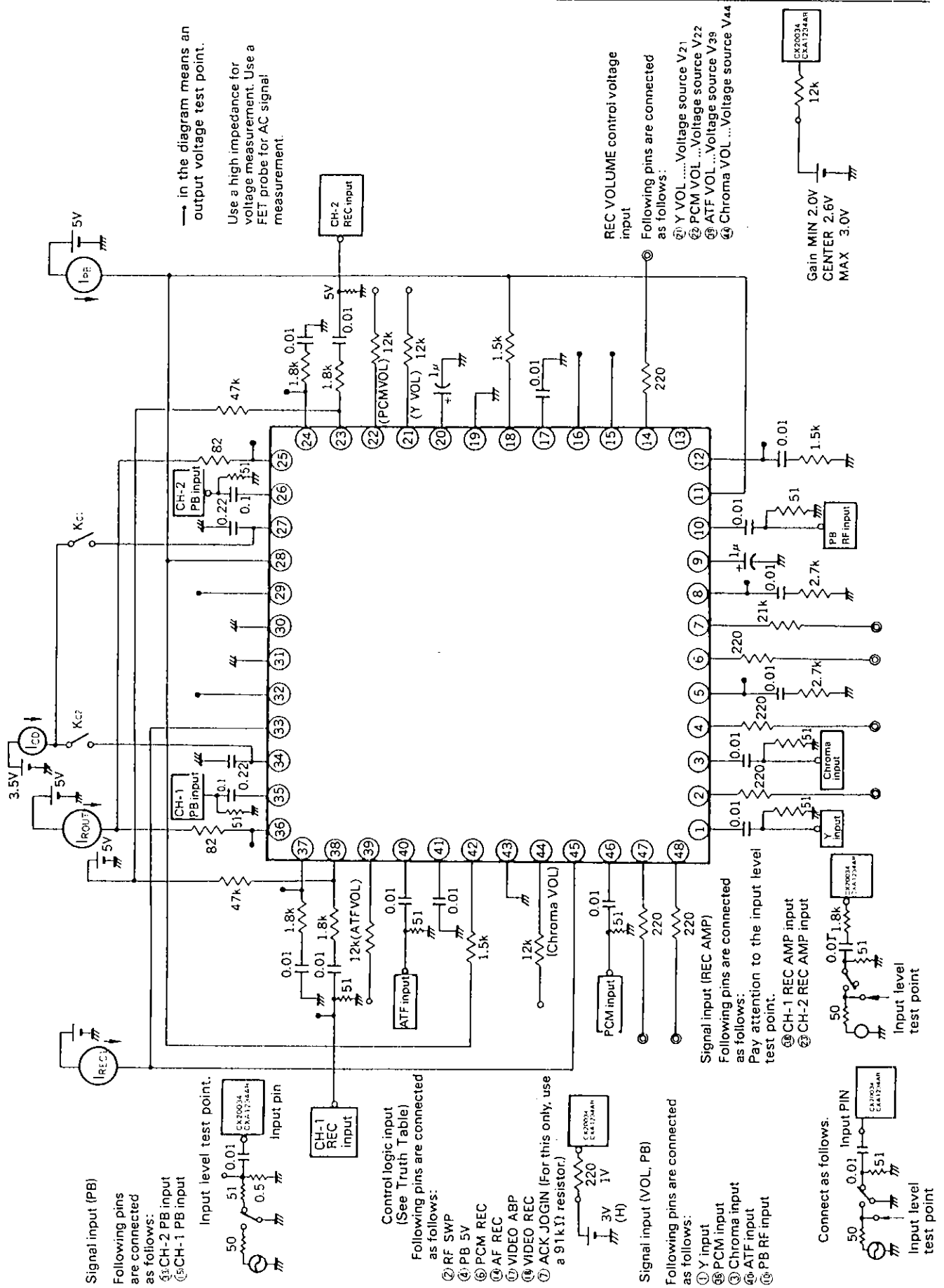

Signal input (PB)
Following pins are connected as follows:
① CH-2 PB input
② CH-1 PB input

Input level test point.
50 0.01 0.01 0.01
CX20034
CXA1234AR
Input pin

Control logic input (See Truth Table)
Following pins are connected as follows:
② RF SWP
④ PB 5V
⑤ PCM REC
⑥ AF REC
⑦ VIDEO ABP
⑧ VIDEO REC
⑩ ACK JOGIN (For this only, use a 91k Ω resistor)

Signal input (VOL, PB)
Following pins are connected as follows:
① Y input
② PCM input
③ Chroma input
④ ATF input
⑤ PB RF input

Signal input (REC AMP)
Following pins are connected as follows:
Pay attention to the input level test point.
① CH-1 REC AMP input
② CH-2 REC AMP input

Connect as follows.
50 0.01 0.01 0.01
CX20034
CXA1234AR
Input PIN
Input level test point

REC VOLUME control voltage input
Following pins are connected as follows:
① Y VOL ... Voltage source V21
② PCM VOL ... Voltage source V22
③ ATF VOL ... Voltage source V38
④ Chroma VOL ... Voltage source V44

Gain MIN 2.0V
CENTER 2.6V
MAX 3.0V

in the diagram means an output voltage test point.
Use a high impedance for voltage measurement. Use a FET probe for AC signal measurement.

Description of Operations

The CX20034/CXA1234AR has following functional blocks.

1. REC, VOL + SW section.
2. REC AMP section.
3. PB HEAD AMP section.
4. PB 2nd RF AMP + SW section.
5. CONTROL LOGIC section.

The CX20034/CXA1234AR has 4 power supply and GND pairs for above systems, 1, 2, 3, and 4, 5 (common). The following is a description for each block.

<REC VOL + SW>

Here, each of the Y, Chroma, PCM and ATF signals are input and the VIDEO + ATF and PCM + ATF signals are generated with the level matched in the head to the correct current and they are output with the correct timing to the CH-1 and CH-2 signal output pins.

In the VOL section, the DC voltage (0.4V_{CC} to 0.6V_{CC}, Open not allowable) is applied to each VOL terminal and controls the gain of the 4 inputs independently. In SW, the signal is output to the CH-1 and CH-2 signal output pins in the REC and after recording modes under control of the control logic section.

<REC AMP>

The REC VOL + SW output is input after it is converted into a suitable current by an external resistor, to drive the head. Adjustment of the external resistor makes it possible to set a gain and DC bias current to match that of the head. (Refer to the Example of Application Circuit).

Take care that capacitance coupling will not occur across the input and output.

<PB HEAD AMP>

The playback signal from the head is amplified with low-noise and high gain. For example, the equivalent input noise level at 1MHz is 696pV/√Hz (Typ). The C/D (Charge/Discharge) circuit is a circuit used to rapidly charge or discharge the head amp bypass condenser.

In switching from PB to REC, it serves to shorten the switching time by rapidly injection current to the bypass condenser for PC1 PIN, and intake current in switching from REC to PB. The switching time is determined by bypass condenser for PC1 and LPC. Selection of values 0.22μF for the PC1 and 0.01μF for LPC, makes it possible to switch within 1 H (≒ 64 μs).

In PB, the total input capacitance will be about 82pF. (Fig.3 example of Application Circuit). However, this capacitance will increase when there is a capacitance coupling across the head input and output. Be careful about the relations between the later stages (RF outputs 1, 2, 3 etc.) and input or between the other channel outputs and inputs.

- Connect a bypass condenser for CH-1 PC1 and CH-2 PC1 between them and the rotary transformer V_{CC}.

<PB 2nd RF AMP + SW>

The playback signal from the head amp is further amplified here and the playback signal is output with the correct timing to the RF outputs 1, 2 and 3 under the control logic section.

<CONTROL LOGIC>

The IC is controlled from this section so it will save power when circuit blocks are not in use. Therefore, power saving is automatically executed when all the power supplies are switched on. Many SWs are also available to switch inputs or outputs with complicated timings; internal logic circuits to control them are provided.

With the 14 modes shown in the control logic condition table, all input and output combinations required for basic operations are satisfied. L is set when the control logic pin is open.

Y VOL + SW Typical Performance Curves

(Pin 1) input → Pin (3) output,
with Pin 21 controlling gain.

Control voltage 2.0V → Minimum gain.
2.6V → Typical gain.
3.0V → Maximum gain.

Output level vs. Y VOL control voltage

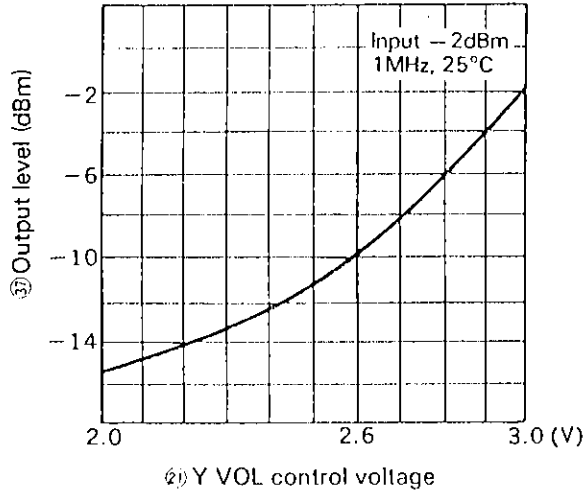

Output level vs. Frequency

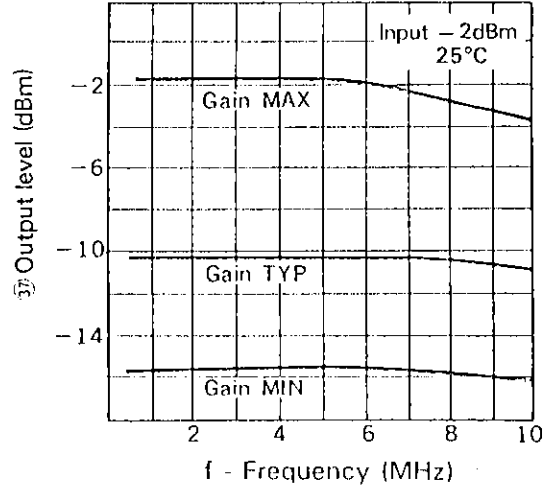

Output level vs. Ambient temperature

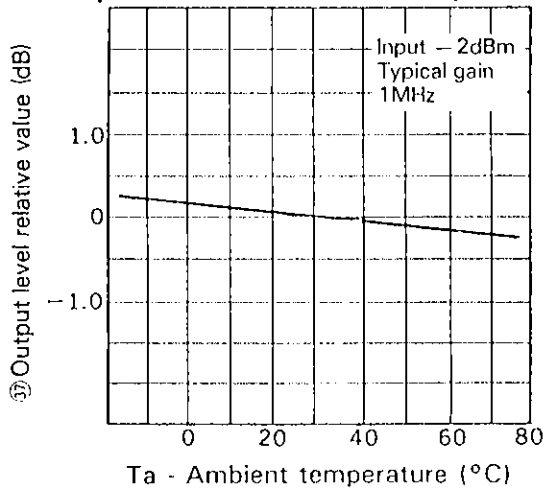

2nd Harmonics

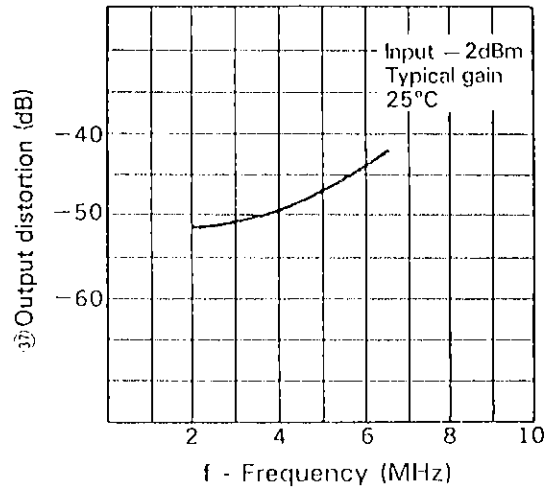

2nd Harmonics vs. Input level

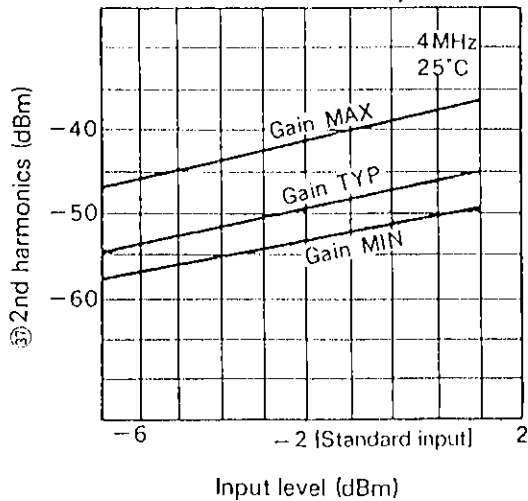

Chroma VOL + SW Typical Performance Curves

(Pin 3 input → Pin 7 output,
with Pin 44 controlling gain.

Control voltage 2.0V → Minimum gain.
2.6V → Typical gain.
3.0V → Maximum gain.

Output level vs. Chroma VOL control voltage

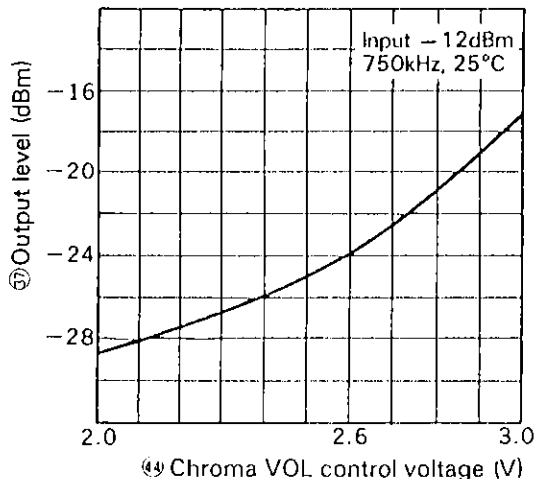

Output level vs. Temperature

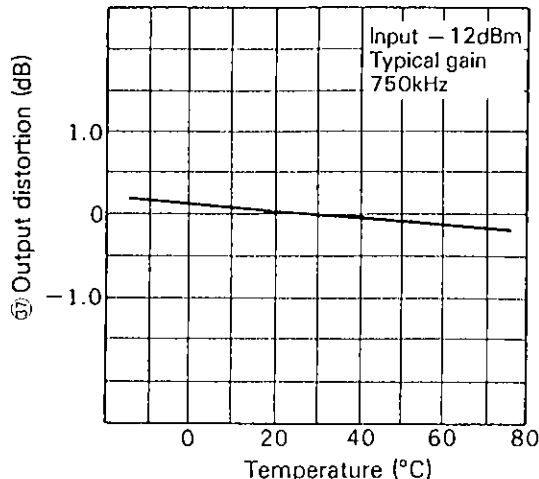

2nd Harmonics vs. Input level

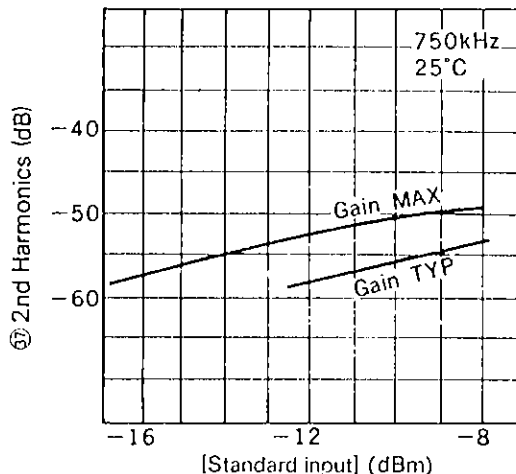

PCM VOL + SW Typical Performance Curves

(Pin 46 input → Pin 37 output,
with Pin 22 controlling gain.

Control voltage 2.0V → Minimum gain.
2.6V → Typical gain.
3.0V → Maximum gain.

Output level vs. PCM VOL control voltage

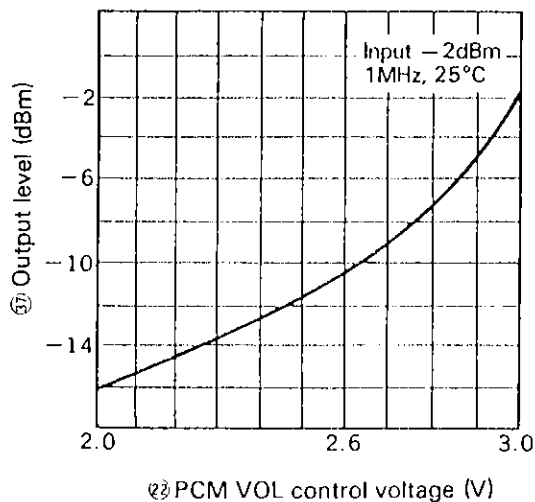

Output level vs. Frequency

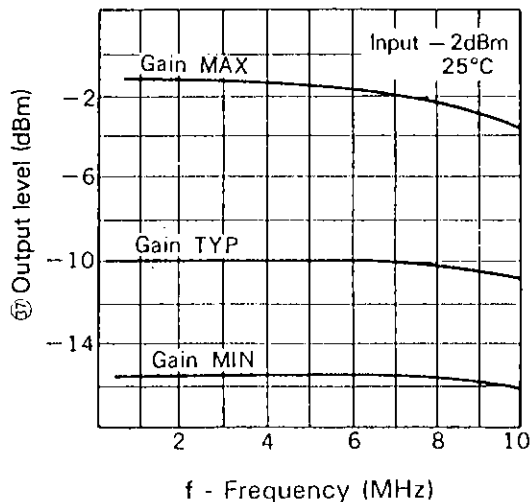

Output level vs. Ambient temperature

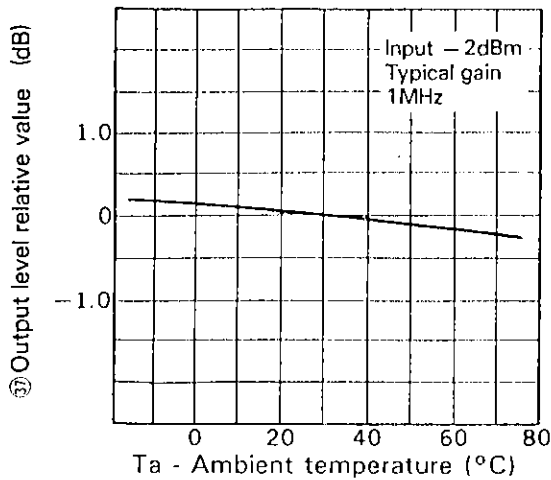

2nd Harmonics vs. Input level

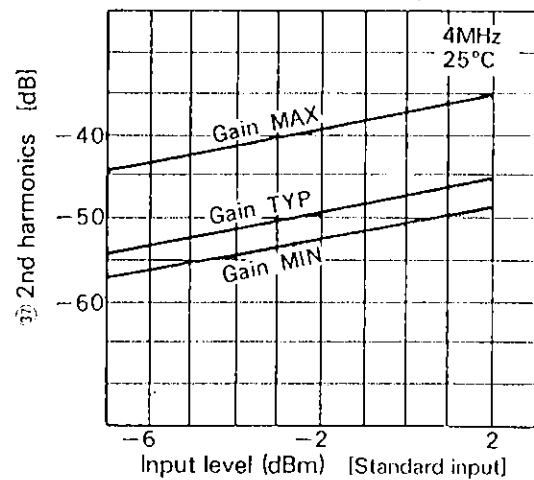

ATF VOL + SW Typical Performance Curves

(Pin 40) input → (Pin 37) output, with Pin 39 controlling gain.

- Control voltage 2.0V → Minimum gain.
- 2.6V → Typical gain.
- 3.0V → Maximum gain.

Output level vs. Control voltage

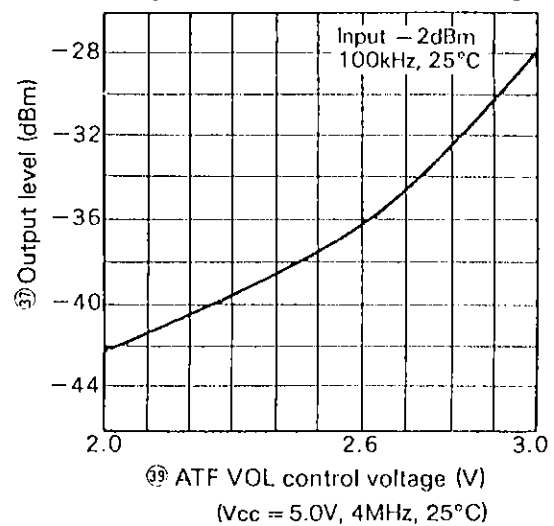

REC AMP Reference Characteristics

Pin 38 input → Pin 36 output

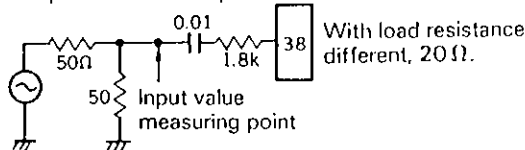

Distortion factor vs. Input level, Output current

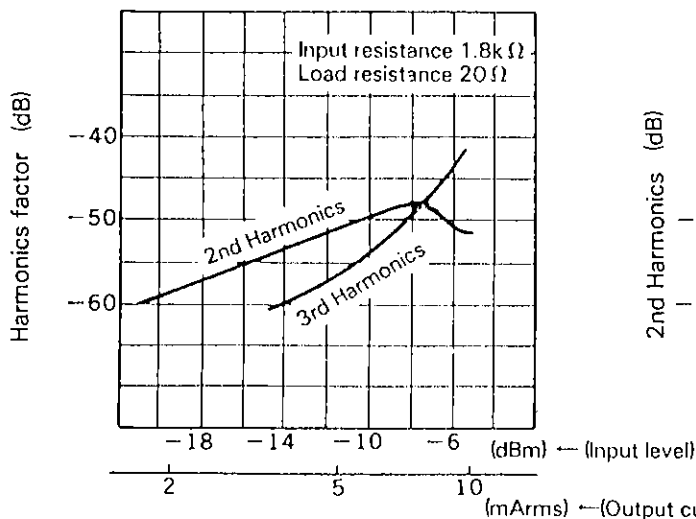

2nd Harmonics vs. Ambient temperature

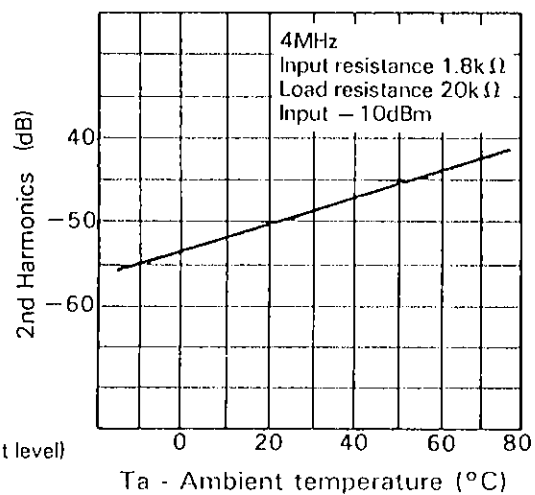

Current gain vs. Ambient temperature

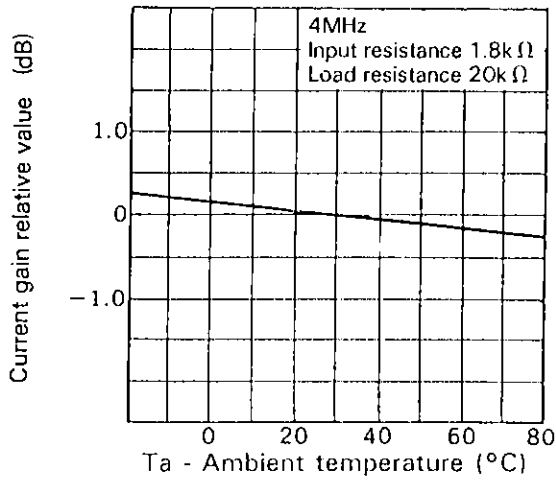

2nd Harmonics vs. Frequency

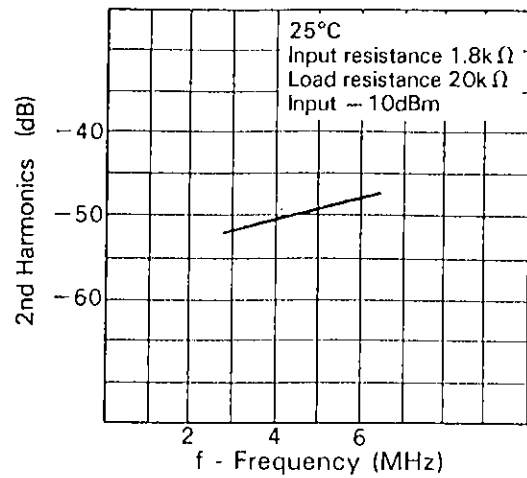

Output level relative value vs. Frequency

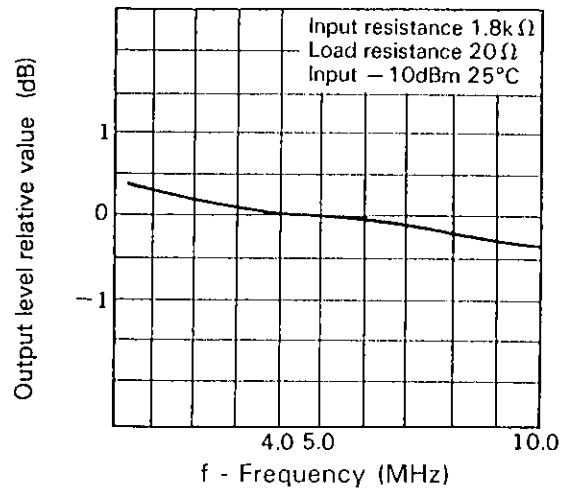

PB Typical Performance Curves

With Vcc = 5.0V in the Electrical Characteristics measuring Circuit, Pin 35 input → Pin 5 output.

RF output 2 output level vs. PB input level

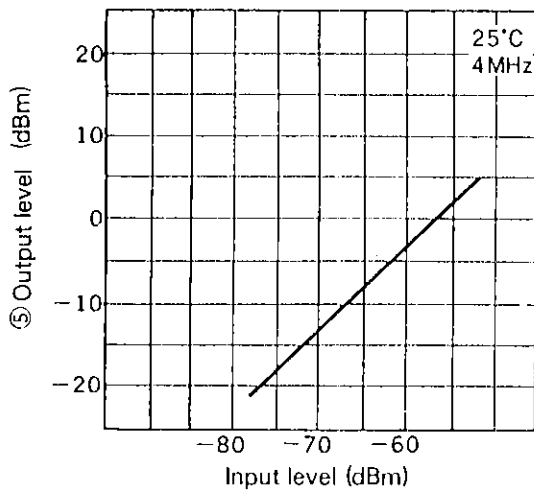

RF output 2 output level vs. Frequency

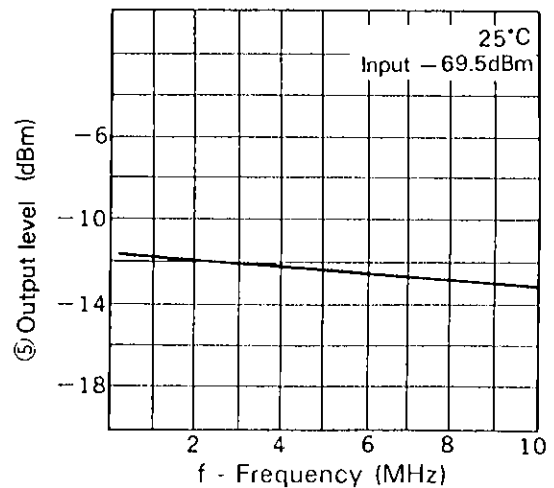

RF output 2 output level vs. Ambient temperature

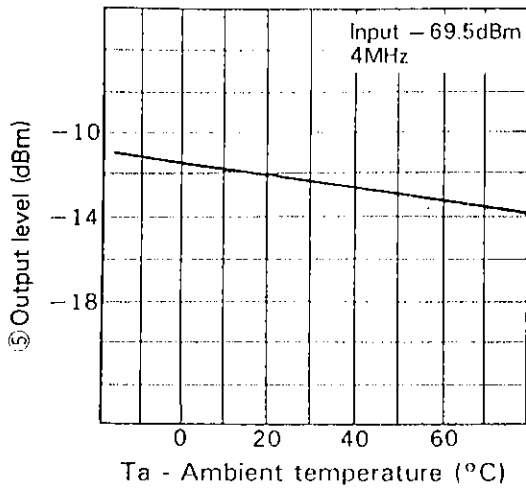

2nd Harmonics vs. Input level

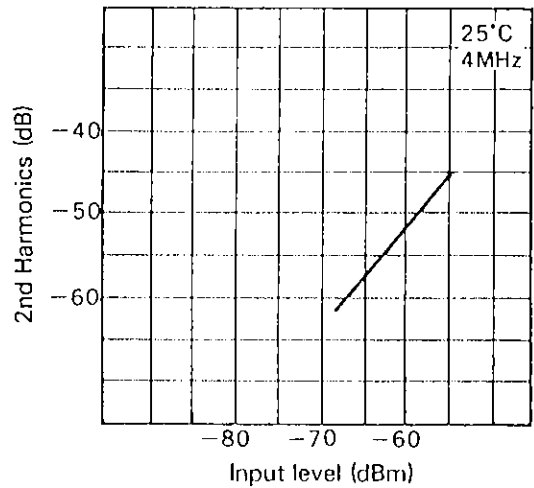

Crosstalk Typical Performance Curves

REC PCM VOL + SW crosstalk vs. Frequency

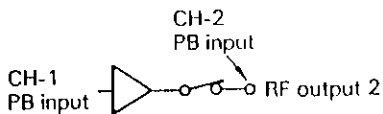
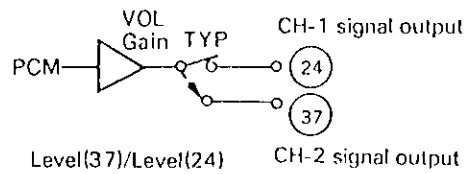
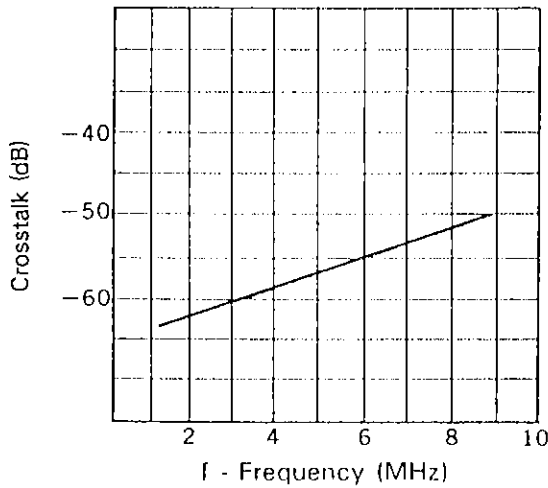

CH-2 → CH-1 crosstalk with PB RF output 2 vs. Frequency

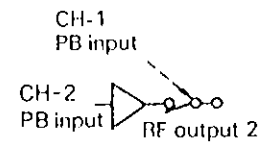
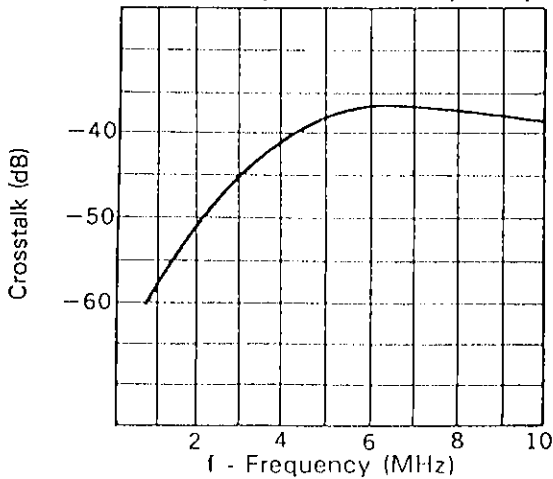

CH-1 → CH-2 crosstalk with PB RF output 2 vs. Frequency

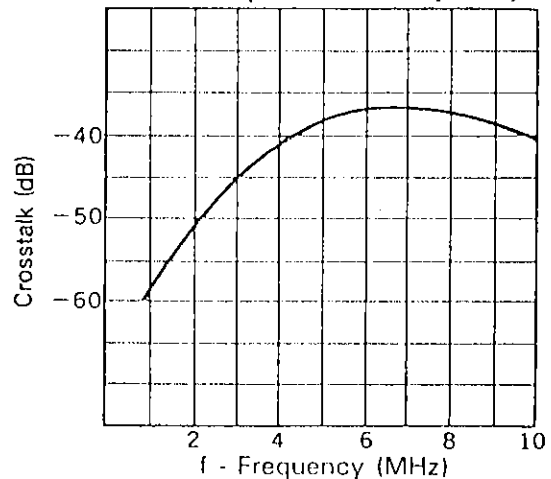

CH-2 → CH-1 crosstalk with
PB RF OUTPUT 3 vs. Frequency

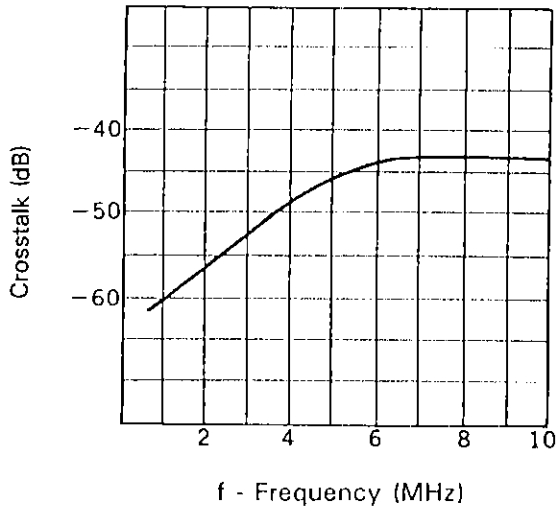

CH-1 → CH-2 crosstalk with
PB RF OUTPUT 3 vs. Frequency

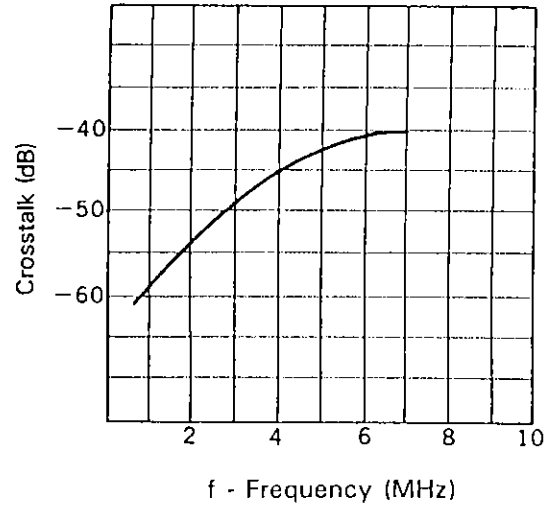

Package Outline Unit : mm

CX20034 48pin QFP(Plastic) 0.6g

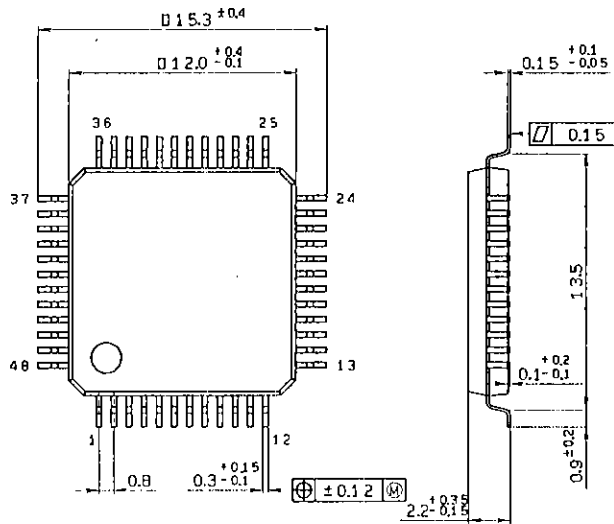

QFP-48P-L04

CXA1234AR 48pin VQFP(Plastic) 0.2g

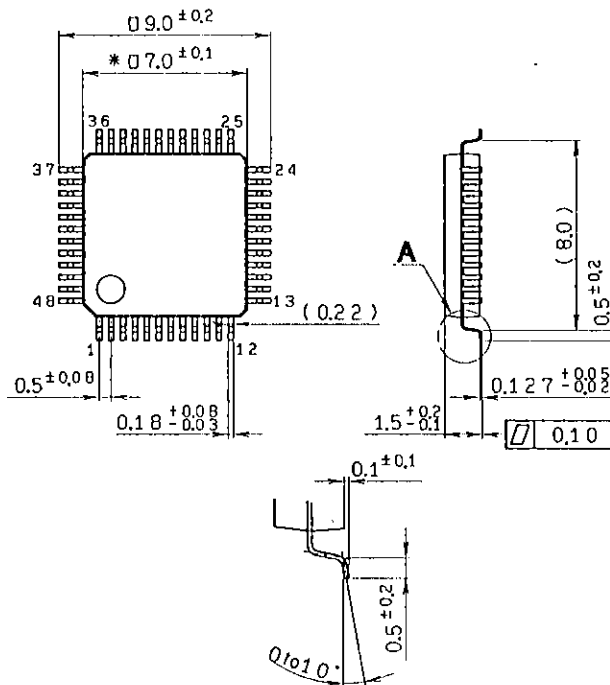

VQFP-48P-L01